

**Get Set**

**Go!**

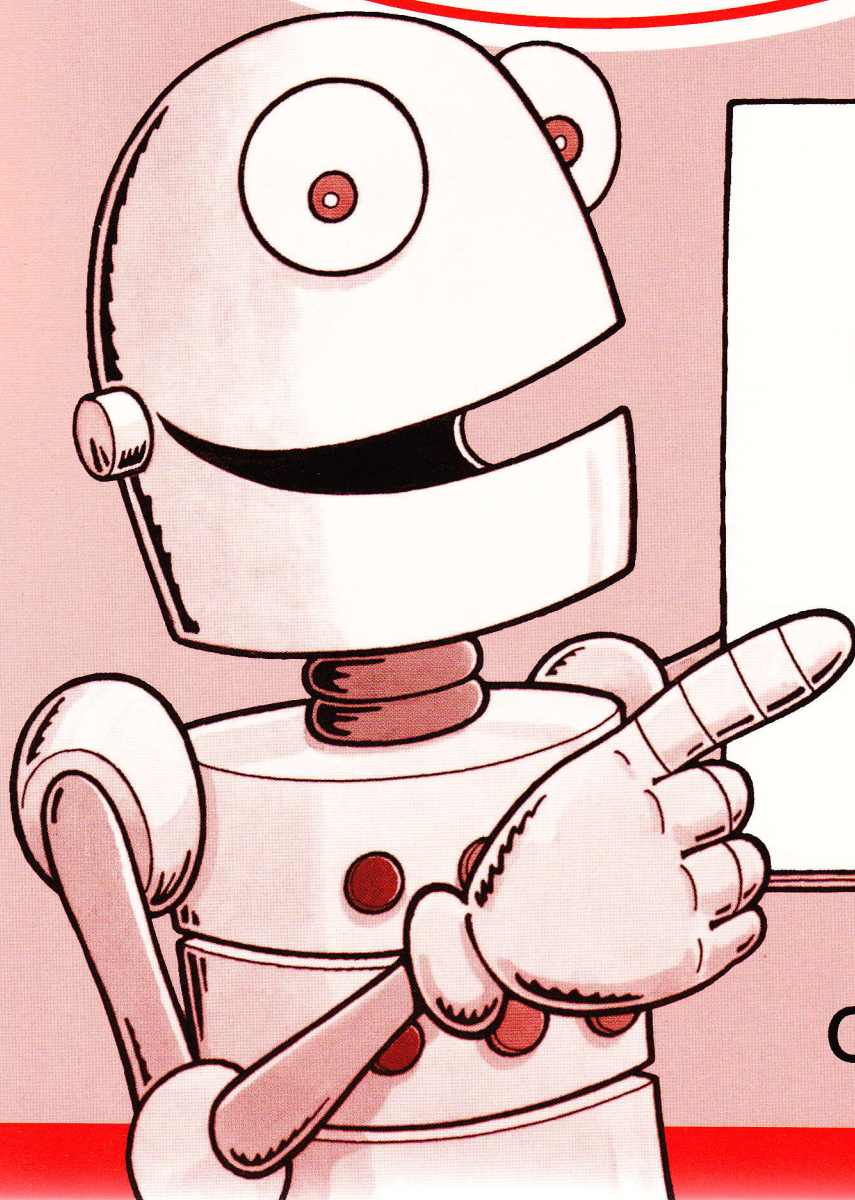

**Workbook**

**1**

**Cathy Lawday**



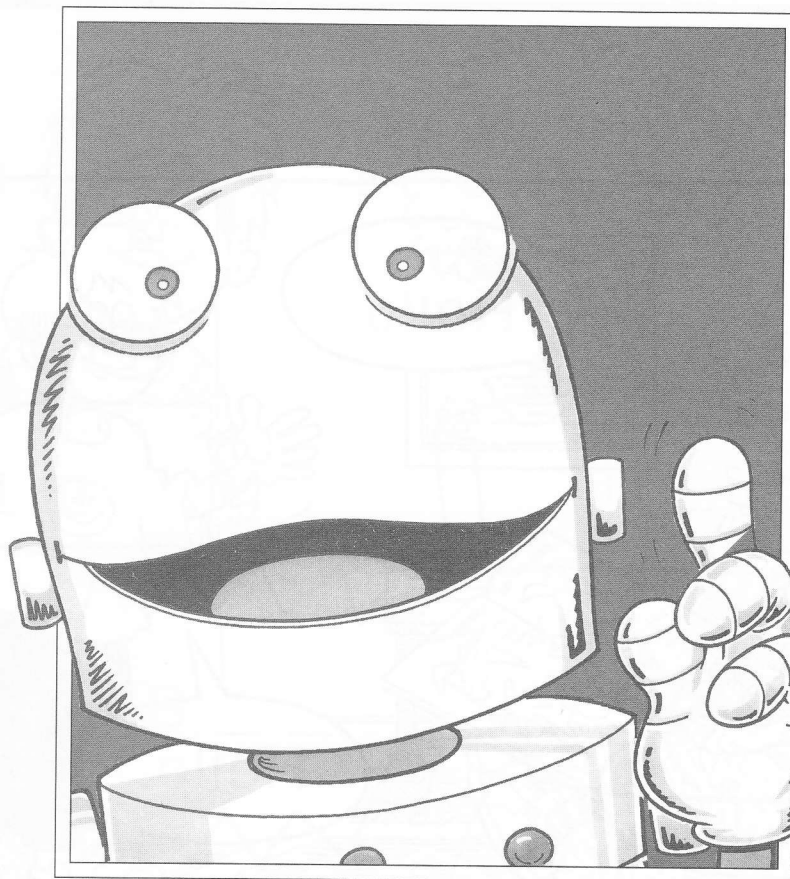

## OXFORD

UNIVERSITY PRESS

Great Clarendon Street, Oxford OX2 6DP

Oxford University Press is a department of the University of Oxford. It furthers the University's objective of excellence in research, scholarship, and education by publishing worldwide in  
Oxford New York

Auckland Cape Town Dar es Salaam Hong Kong Karachi  
Kuala Lumpur Madrid Melbourne Mexico City Nairobi  
New Delhi Shanghai Taipei Toronto

With offices in

Argentina Austria Brazil Chile Czech Republic France Greece  
Guatemala Hungary Italy Japan South Korea Poland Portugal  
Singapore Switzerland Thailand Turkey Ukraine Vietnam

OXFORD and OXFORD ENGLISH are registered trade marks of  
Oxford University Press in the UK and in certain other countries

© Oxford University Press 1995

The moral rights of the author have been asserted

Database right Oxford University Press (maker)

First published 1996

2009 2008

30 29 28 27 26

### No unauthorized photocopying

All rights reserved. No part of this publication may be reproduced, stored in a retrieval system, or transmitted, in any form or by any means, without the prior permission in writing of Oxford University Press, or as expressly permitted by law, or under terms agreed with the appropriate reprographics rights organization. Enquiries concerning reproduction outside the scope of the above should be sent to the ELT Rights Department, Oxford University Press, at the address above

You must not circulate this book in any other binding or cover and you must impose this same condition on any acquirer

Any websites referred to in this publication are in the public domain and their addresses are provided by Oxford University Press for information only. Oxford University Press disclaims any responsibility for the content

ISBN-13: 978-0-19-435056-3

Designed and typeset by Oxprint Design, Oxford

Printed in China

### ACKNOWLEDGEMENTS

Illustrations by: David Lock, Sami Sweeten and Pete Lawrence



● Write





● Write

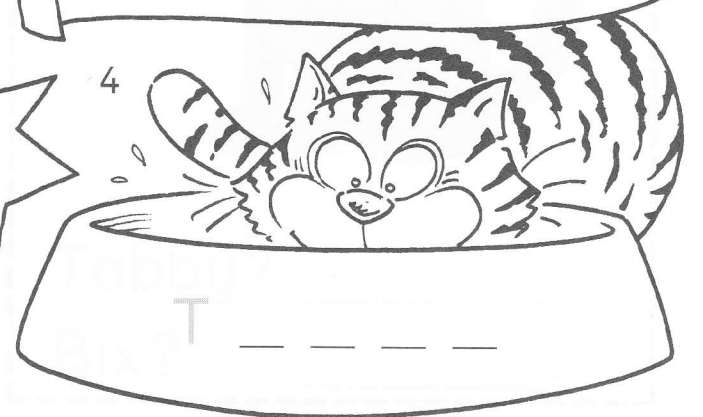
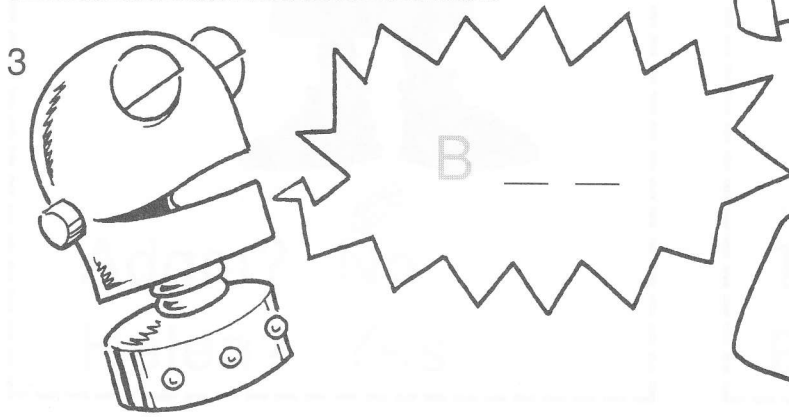
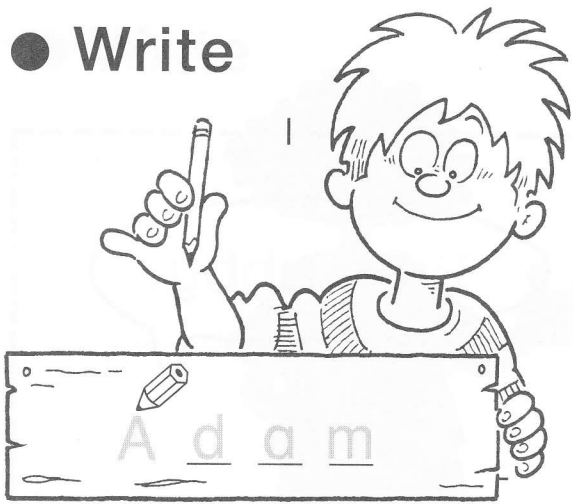

● Write your name

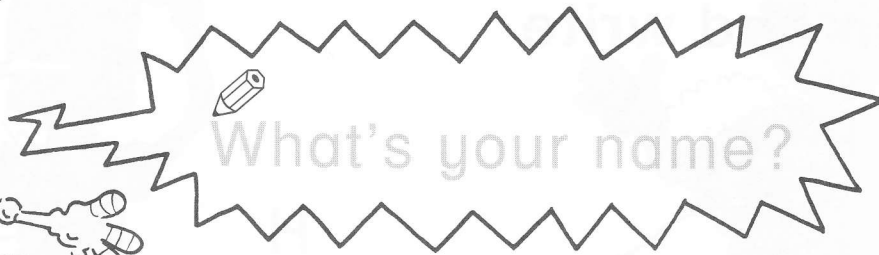
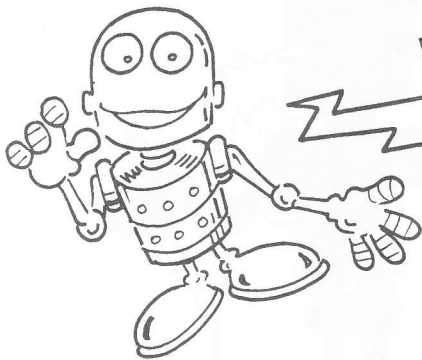

I'm \_\_\_\_\_.

● Odd one out

A H A A H

H T H H \_

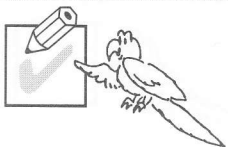



● Draw and write

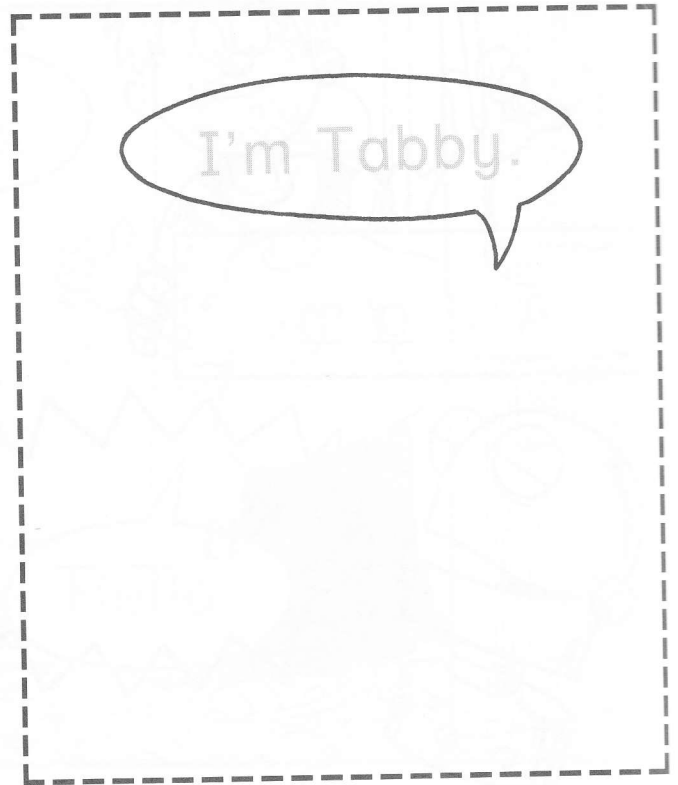

● Match and write

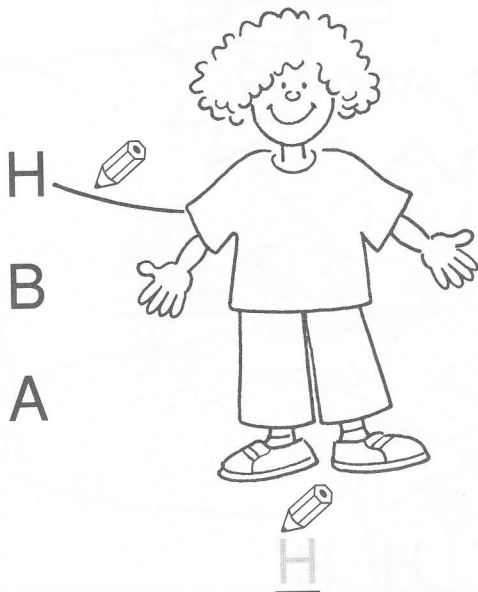



● Write

1



Adam? No.

Helen? Yes.

2

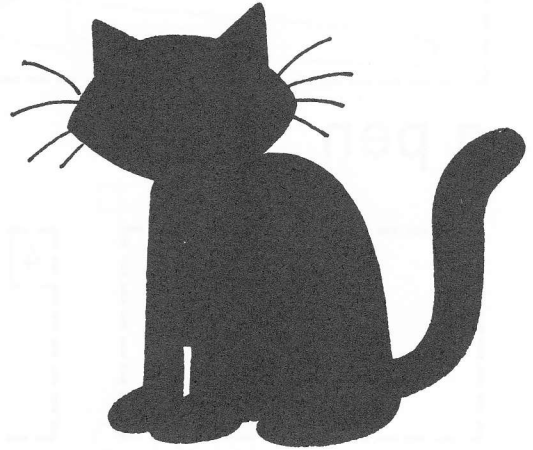

Tabby? \_\_\_\_\_.

Bix? \_\_\_\_\_.

3

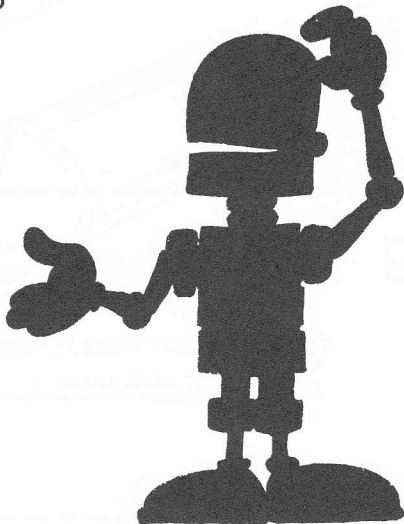

Helen? \_\_\_\_\_.

Bix? \_\_\_\_\_.

4



Adam? \_\_\_\_\_.

Tabby? \_\_\_\_\_.

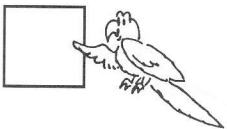



● Read and draw

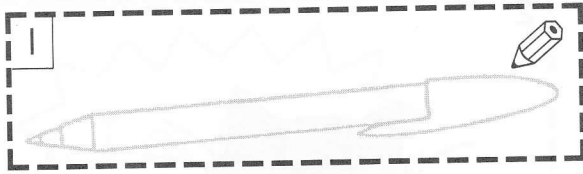

a pen

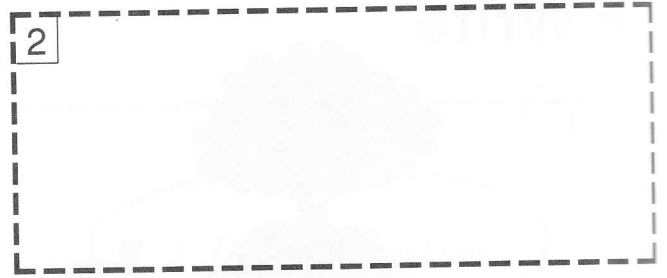

a pencil case



a rubber

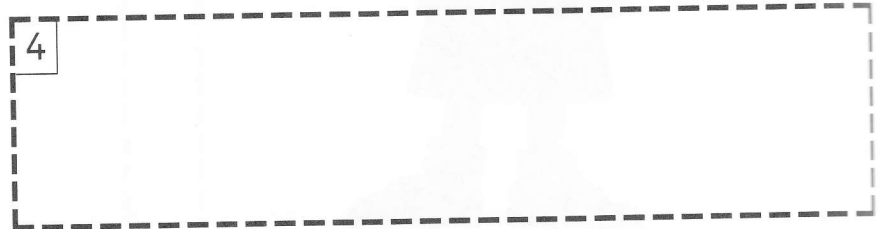

a ruler



a pencil

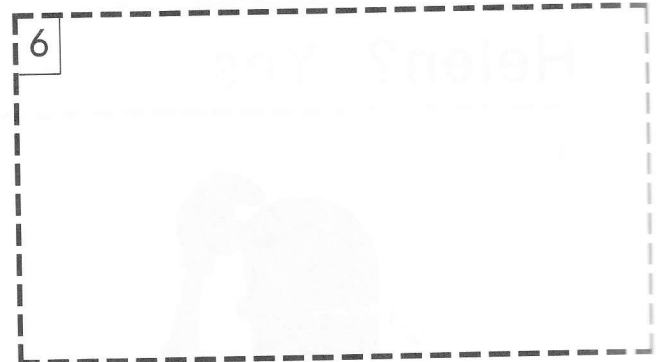

a bag

● Draw your pencil

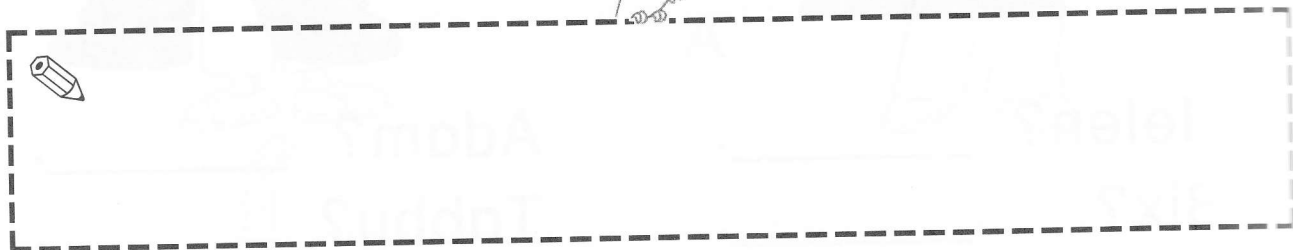

● Match and write

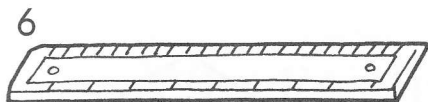
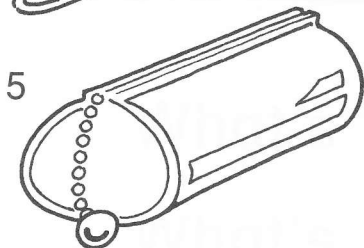
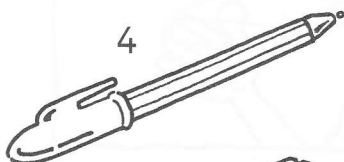
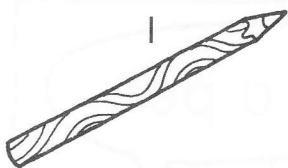

 a bag

a pen

a ruler

a pencil

a rubber

a pencil case

● Odd one out

g g p g  \_

n r n n \_

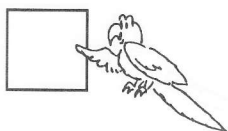



## ● Colour and write

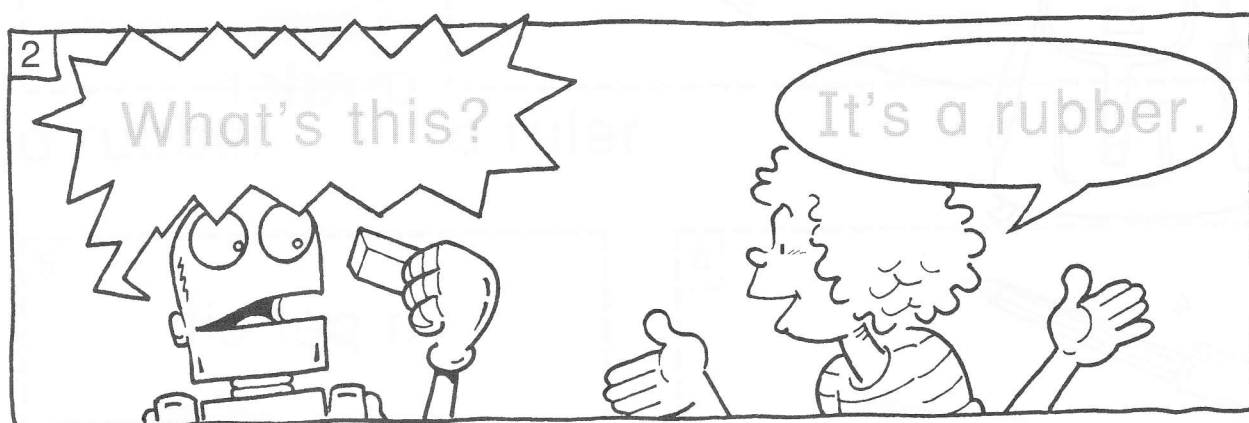
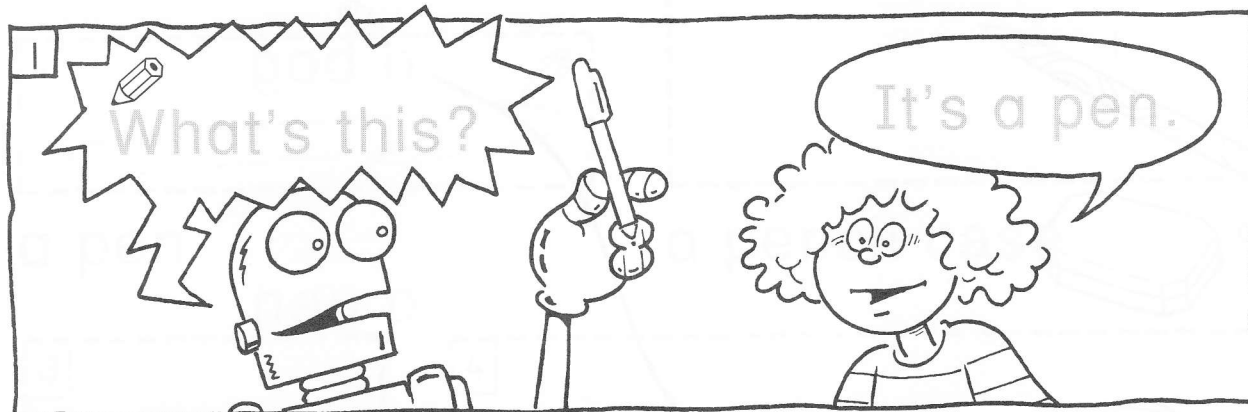

## ● Match and write

b

r

p

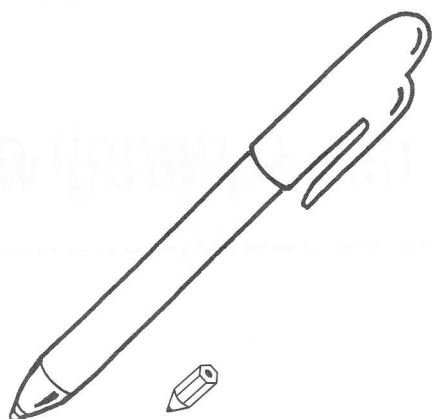

r

b

p

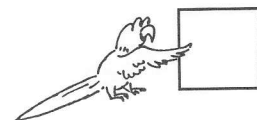
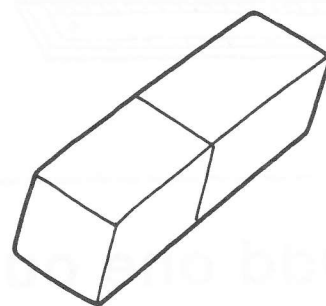

● Write

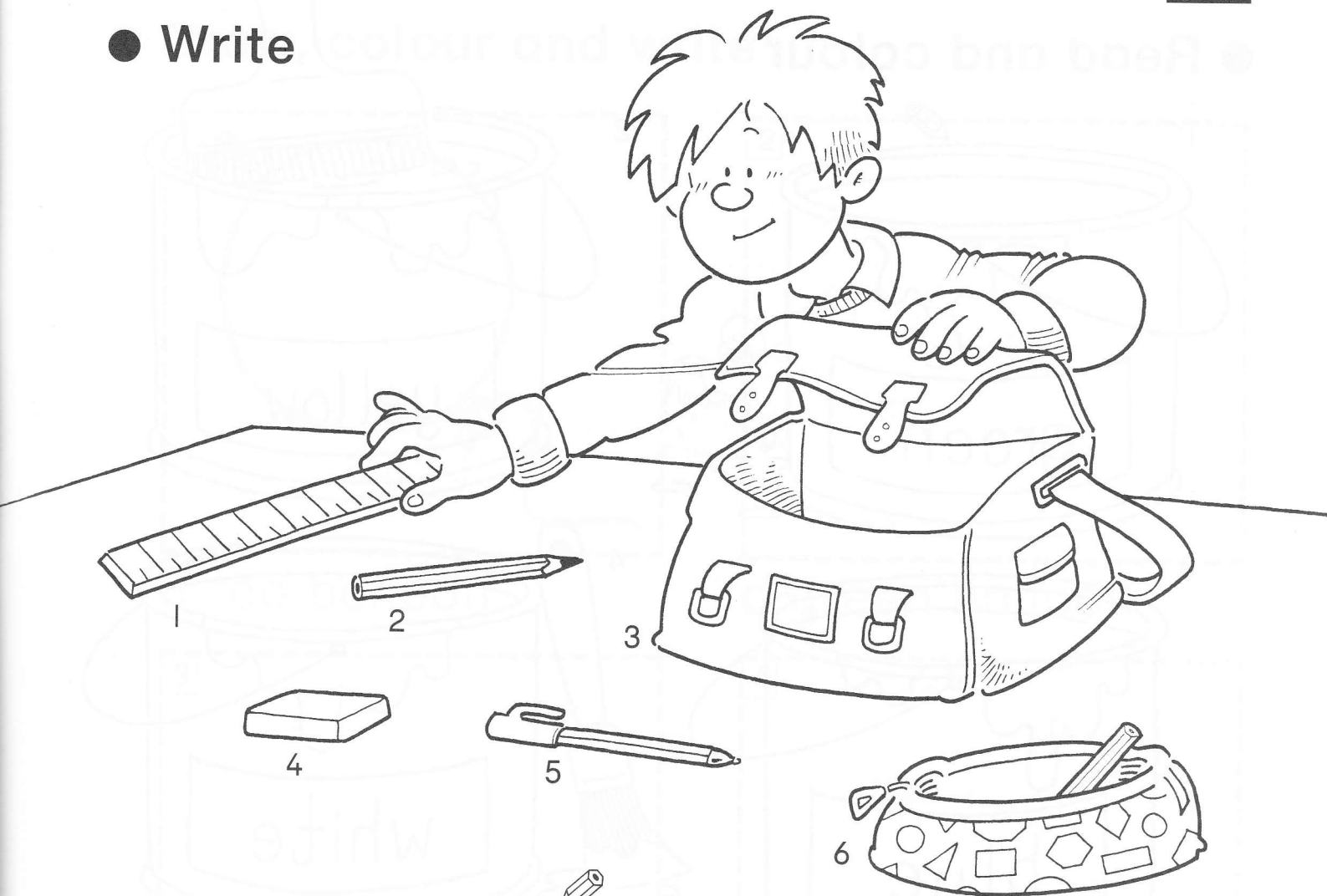

1 What's this? It's a ruler.

2 What's this? It's a pencil.

3 What's this? It's a \_\_\_\_\_.

4 What's this? It's a \_\_\_\_\_.

5 What's this? It's a \_\_\_\_\_.

6 What's this? It's a \_\_\_\_\_.

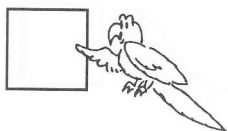
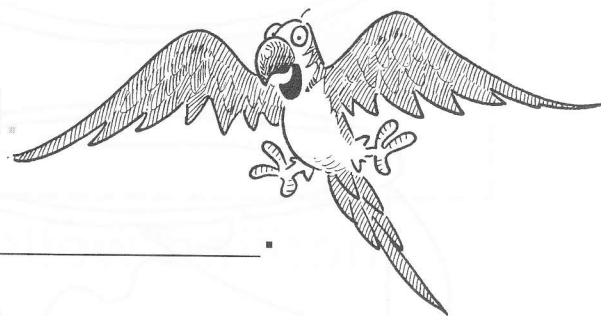



● Read and colour

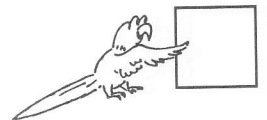
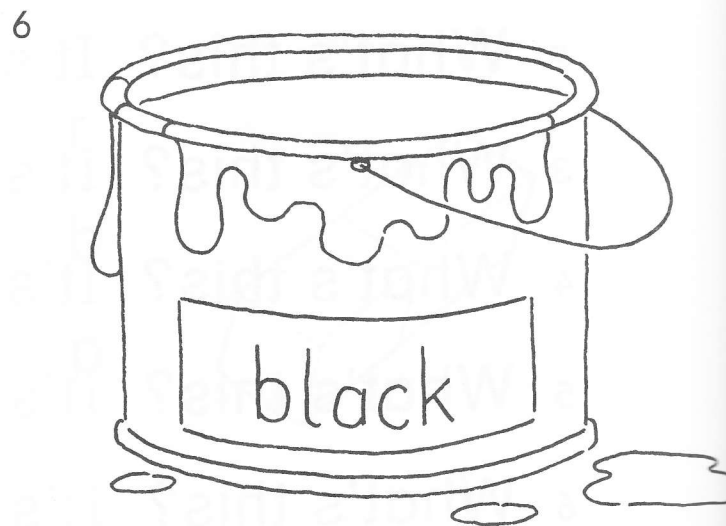
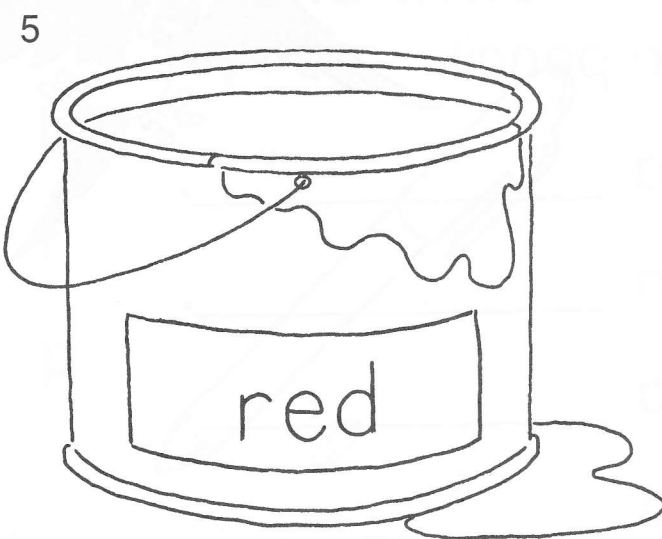
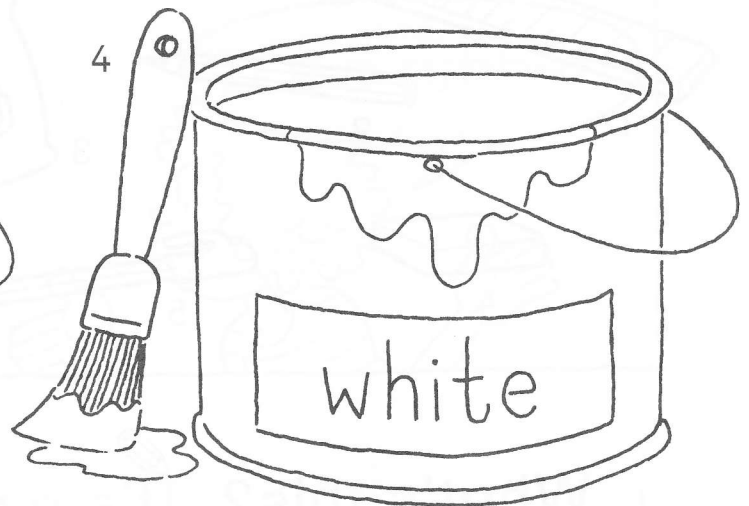
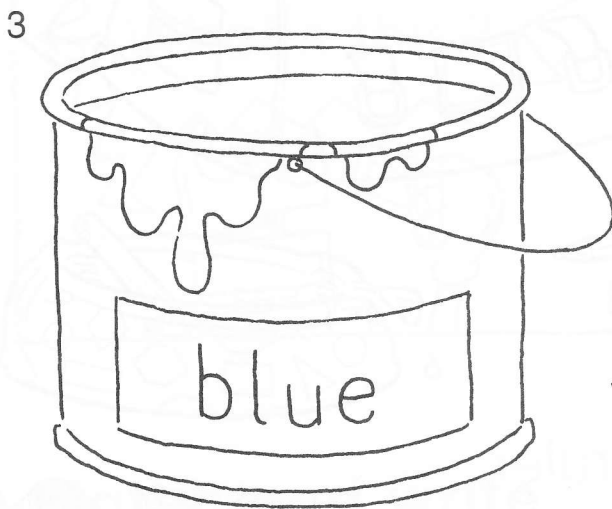
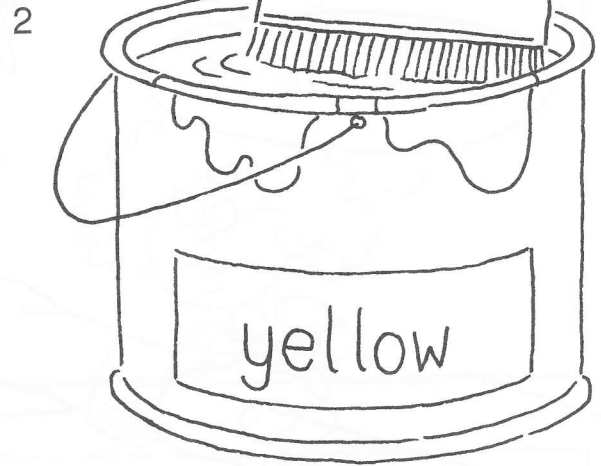
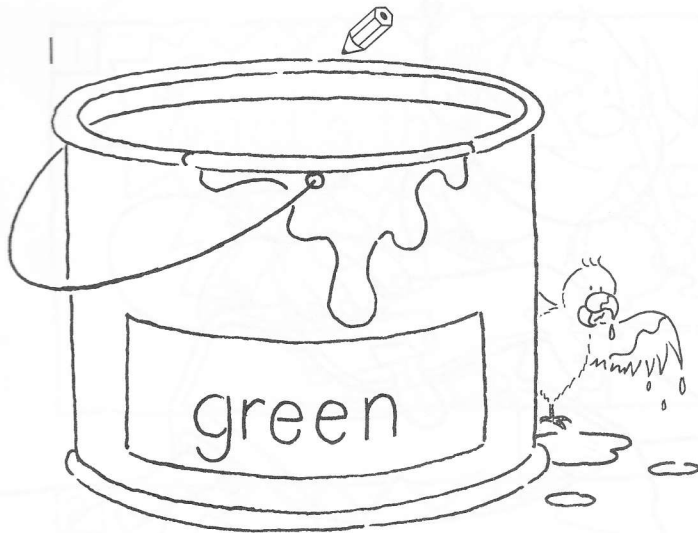

● Draw, colour and write

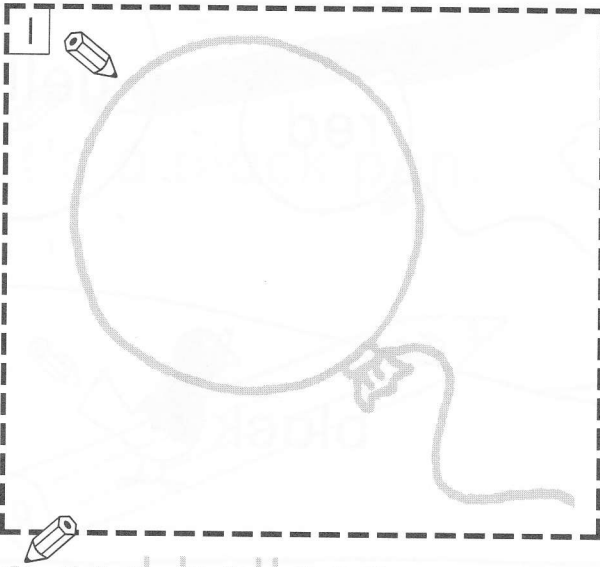

a red balloon

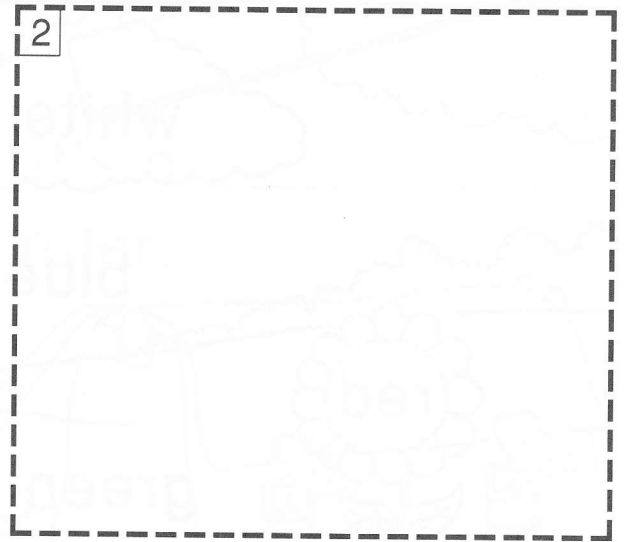

a green balloon



a blue balloon

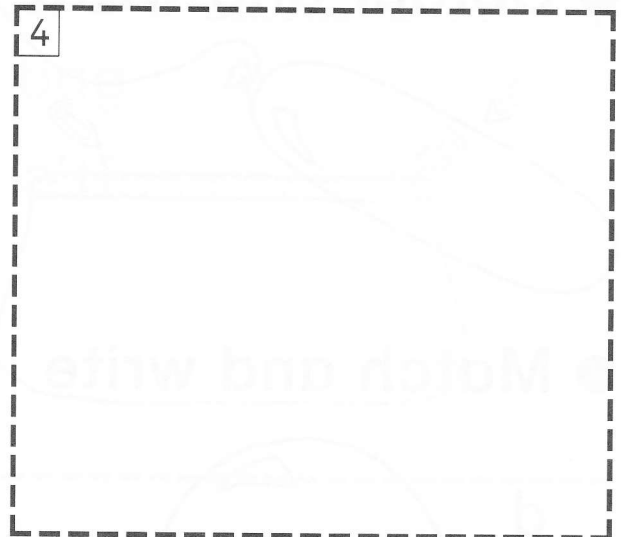

a yellow balloon

● Odd one out 

p b p p \_

w m m m \_

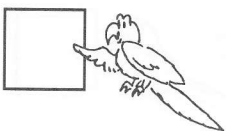



● Read and colour

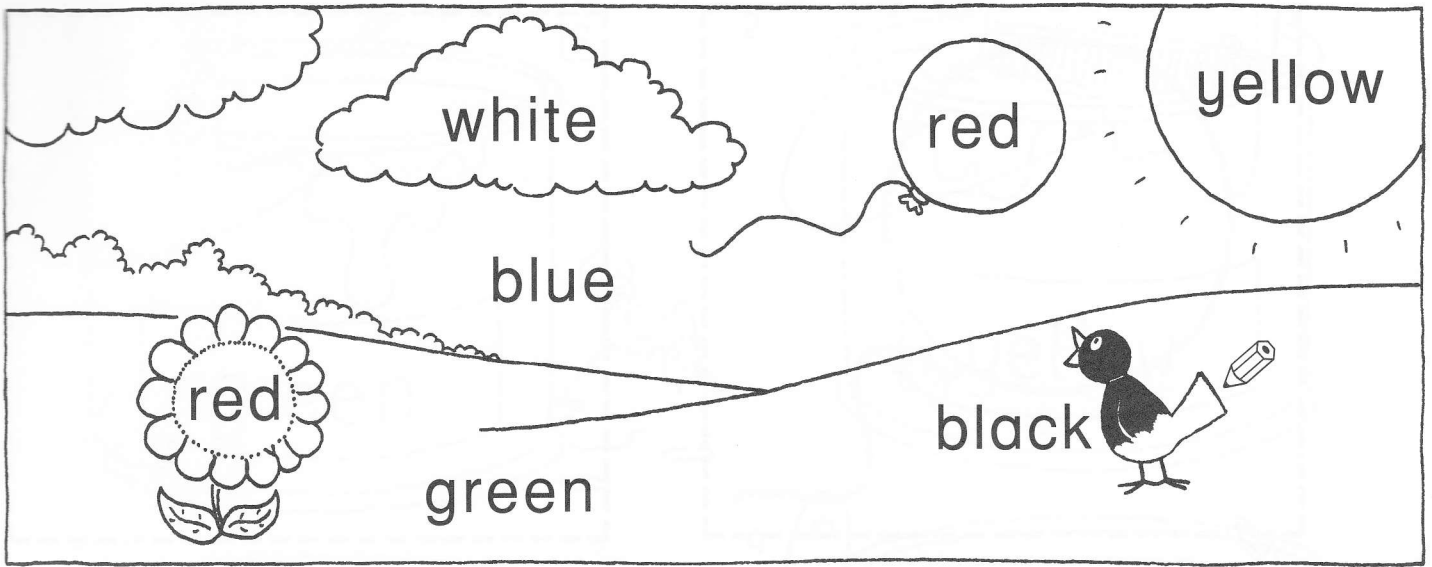

● Colour and write

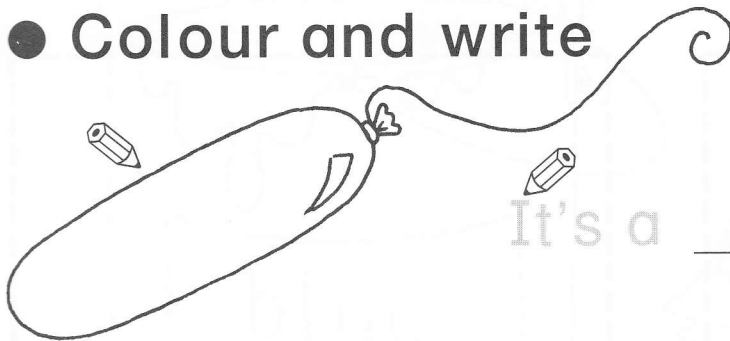

It's a \_\_\_\_\_ balloon.

● Match and write

d  
b  
p

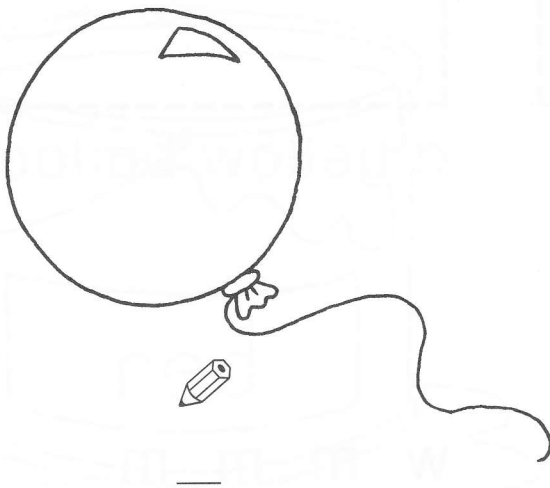

m  
w  
n

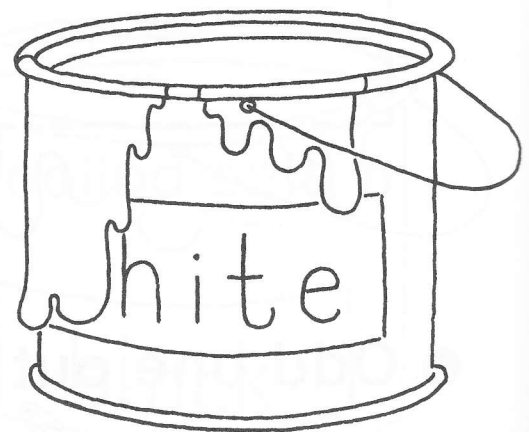

## ● Colour and write



1 It's a black pen.

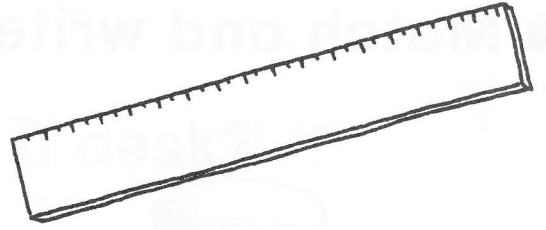

2 It's a \_\_\_\_\_  
ruler.

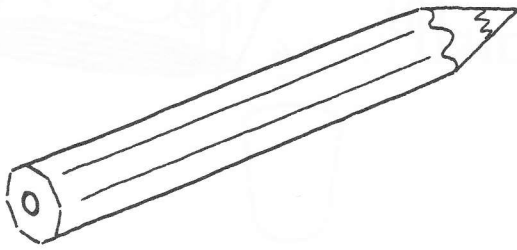

3 It's a \_\_\_\_\_  
pencil.

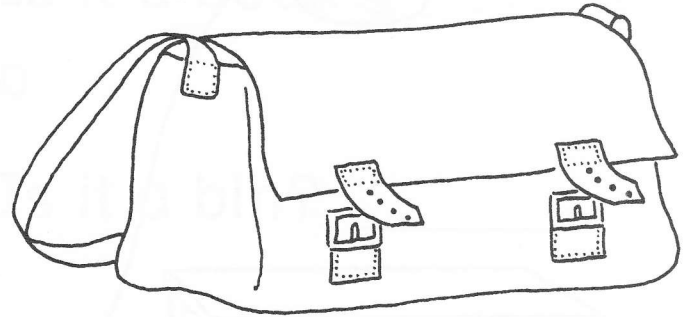

4 It's a \_\_\_\_\_  
bag.

5 It's a \_\_\_\_\_  
pencil case.

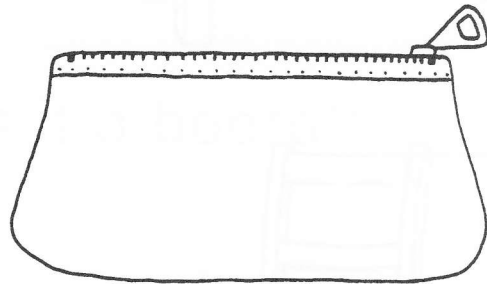

## ● Draw and colour your pencil case

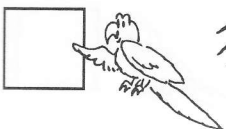
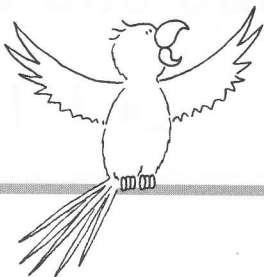
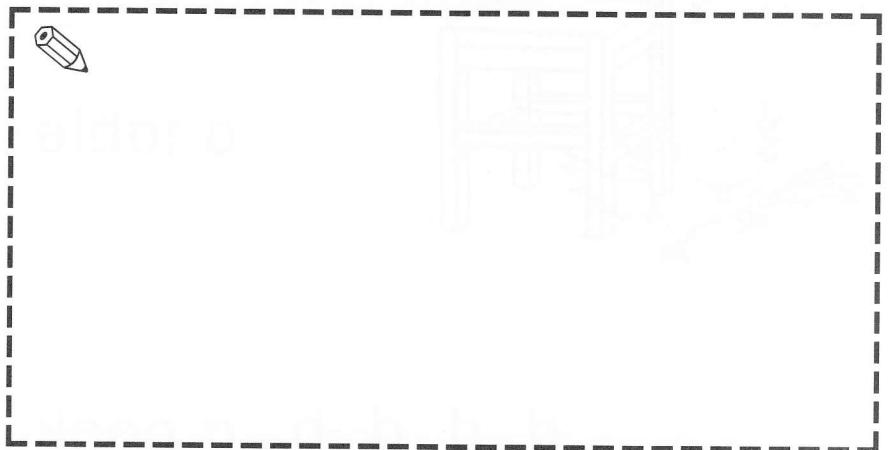

● Match and write

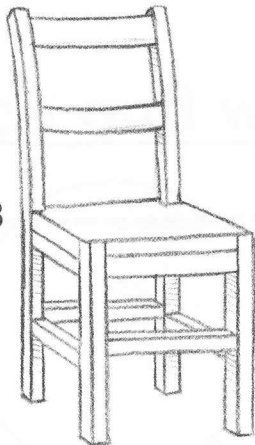
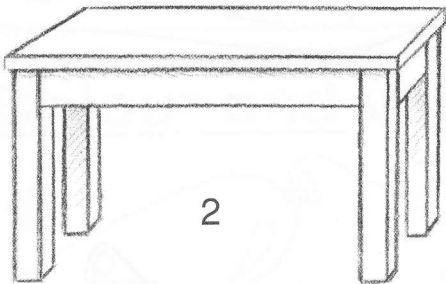
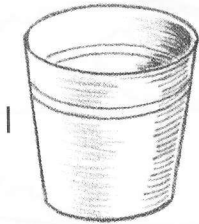

a desk

a chair

a bin

a board

a table

a book

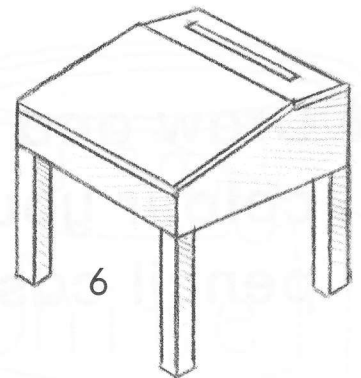
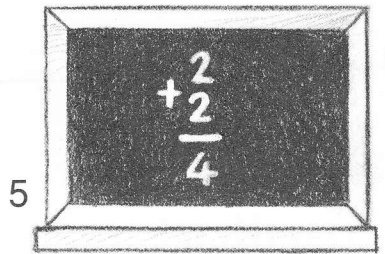
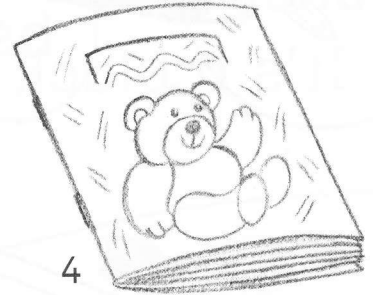



● Write

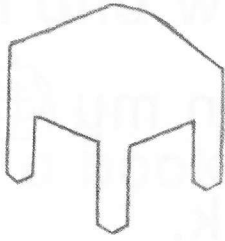

1 Is it a desk? Yes.

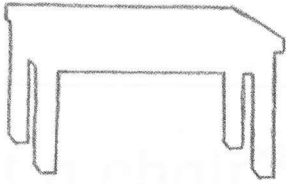

2 Is it a book? No.



3 Is it a bin? \_\_\_\_\_.

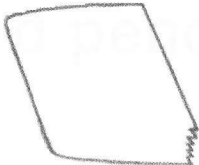

4 Is it a chair? \_\_\_\_\_.



5 Is it a board? \_\_\_\_\_.

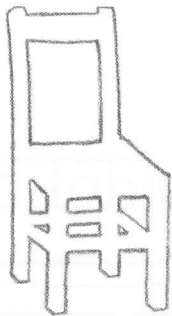

6 Is it a chair? \_\_\_\_\_.





● Odd one out

l l t l \_

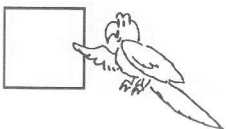

d b b b \_





● Read and write

What's in my  bag? What's in my  \_\_\_\_\_?

Come and look, come and look.

A  \_\_\_\_\_, a  \_\_\_\_\_,

a  \_\_\_\_\_, a  \_\_\_\_\_,

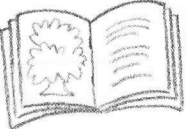
And a  \_\_\_\_\_!

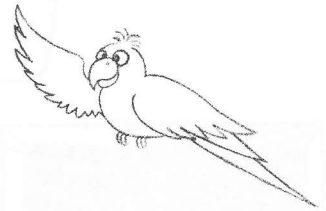

● Write about your bag

What's in your bag? A \_\_\_\_\_

\_\_\_\_\_

● Match and write

b

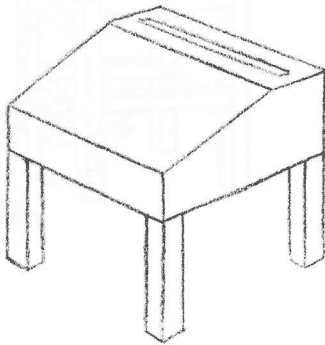

d

p

t

b

l

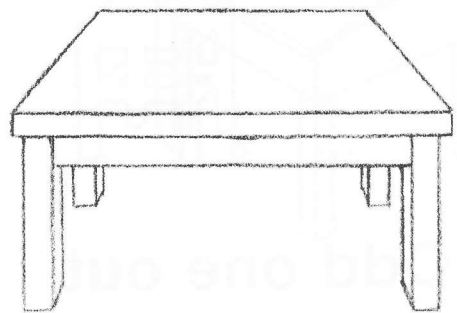

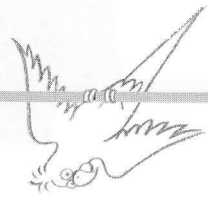

● Match and write

1 Is it a book? Yes.

2 Is it a chair? No.

3 Is it a pencil? \_\_\_\_\_.

4 Is it a board? \_\_\_\_\_.

5 Is it a table? \_\_\_\_\_.

6 Is it a rubber? \_\_\_\_\_.

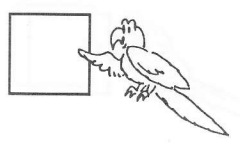
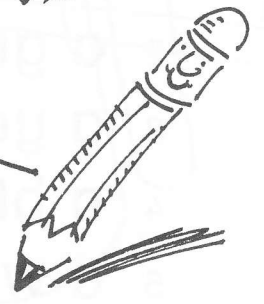
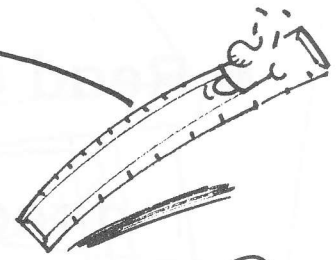
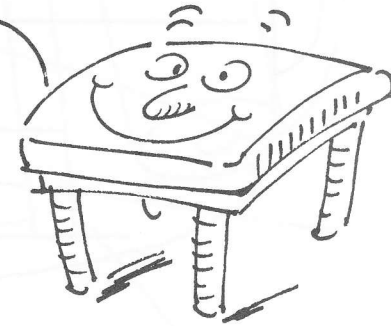
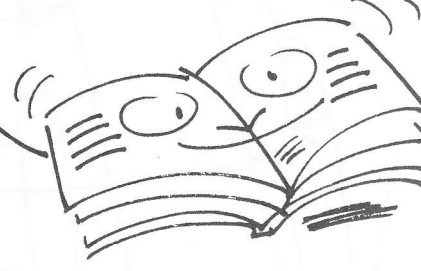
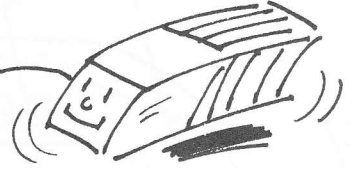
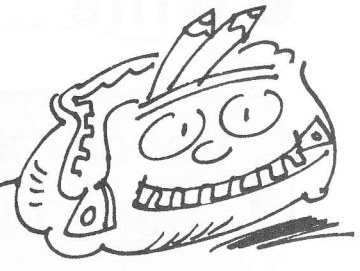

● Write

pencil white rubber yellow green book  
pen black ruler pencil case blue red

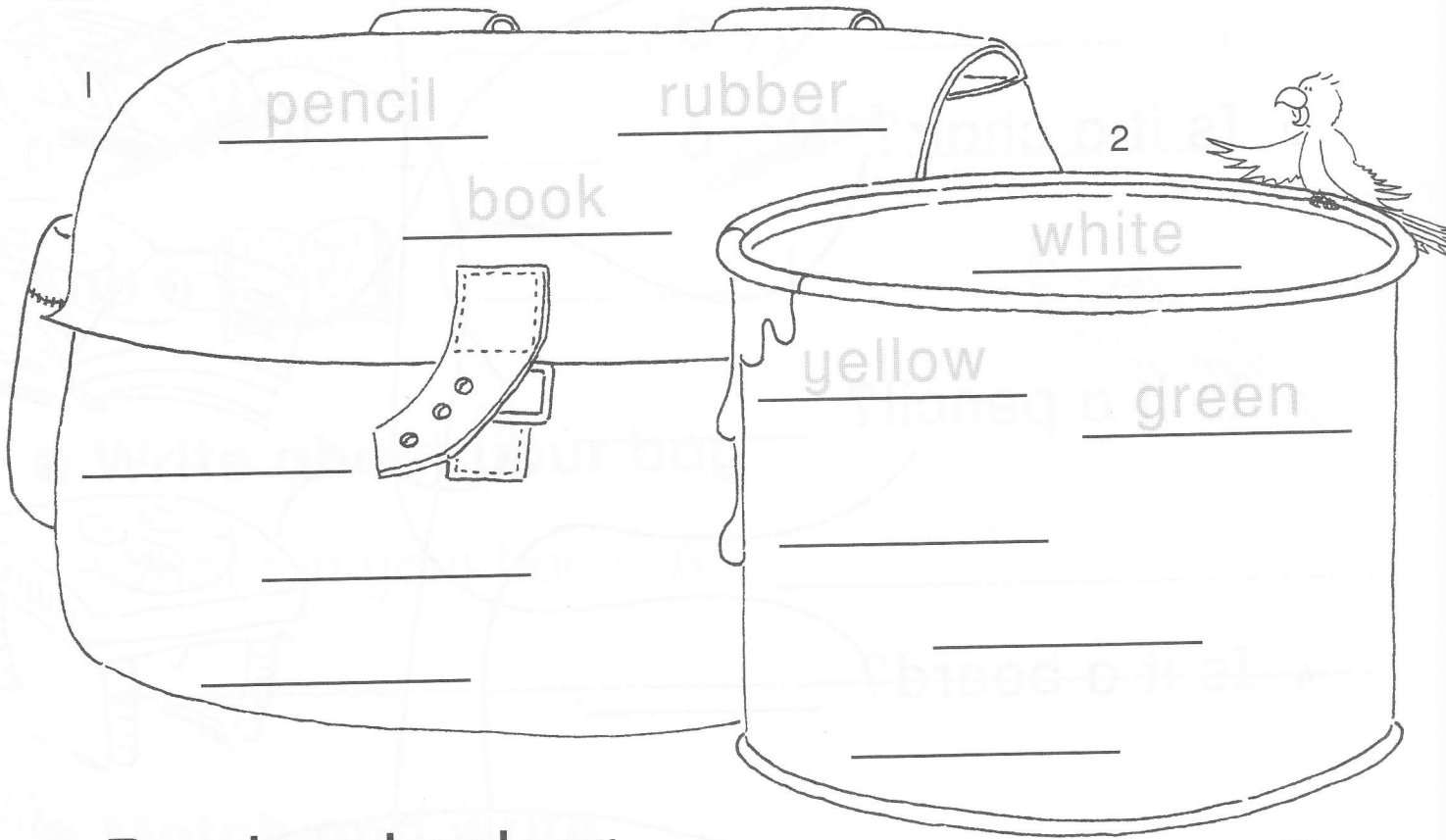

● Read and colour

- 1 a red book
- 2 a green bag
- 3 a yellow ruler
- 4 a blue pencil
- 5 a white balloon

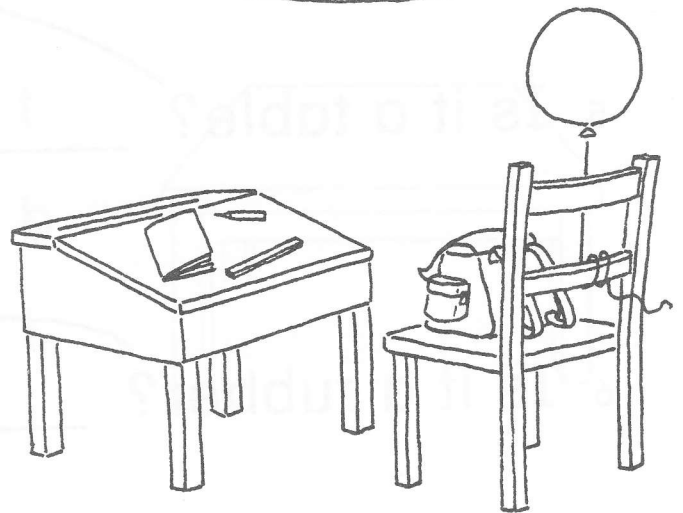



● Write

1 What's this?  
It's a rubber.

2 What's this?  
It's a \_\_\_\_\_.

3 What's this?  
It's a \_\_\_\_\_.

4 What's this?  
It's a \_\_\_\_\_.

5 What's this?  
It's a \_\_\_\_\_.

6 What's this?  
It's a \_\_\_\_\_.

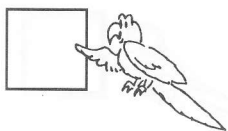
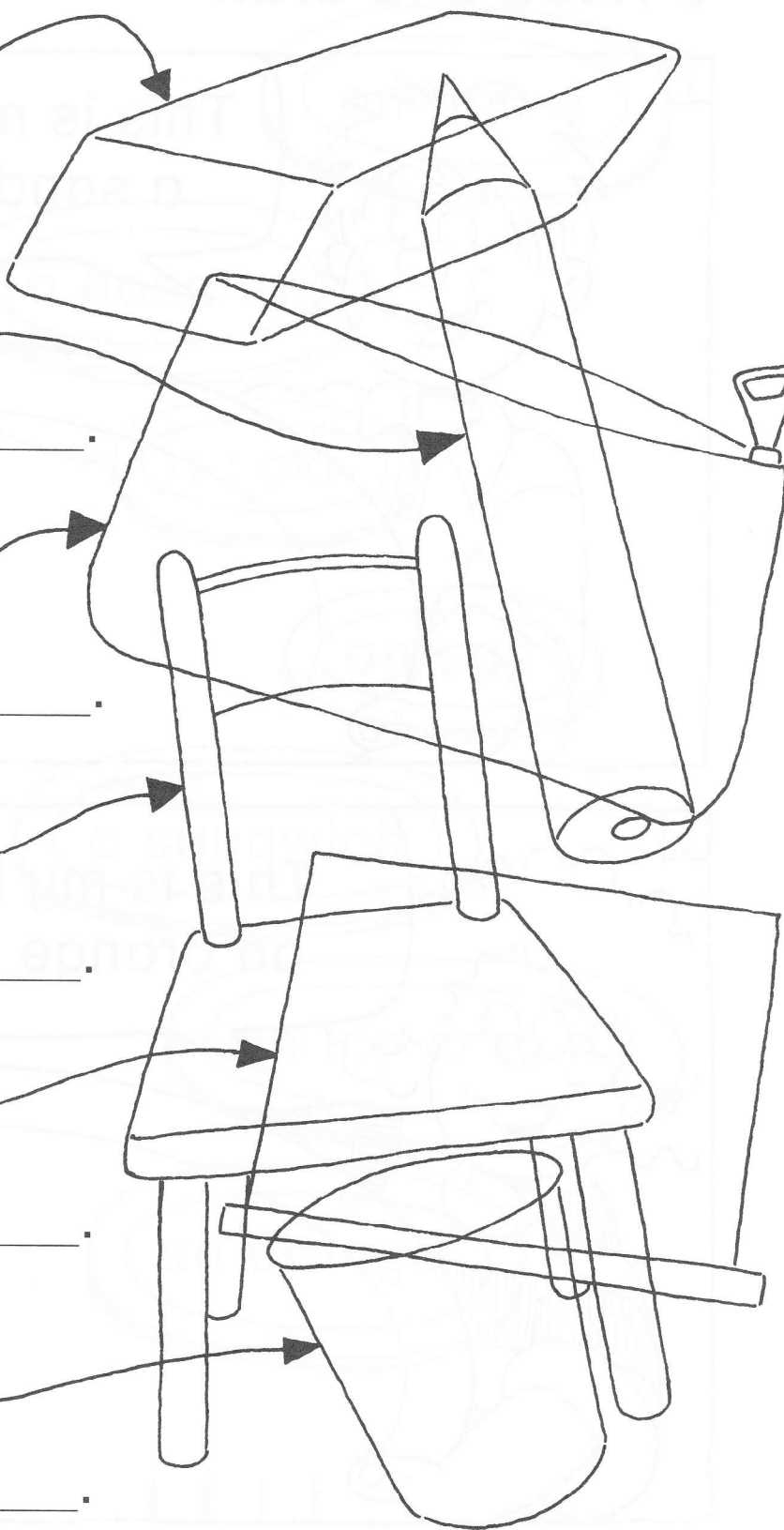

## ● Read and draw

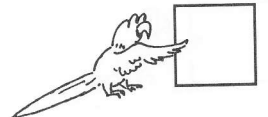
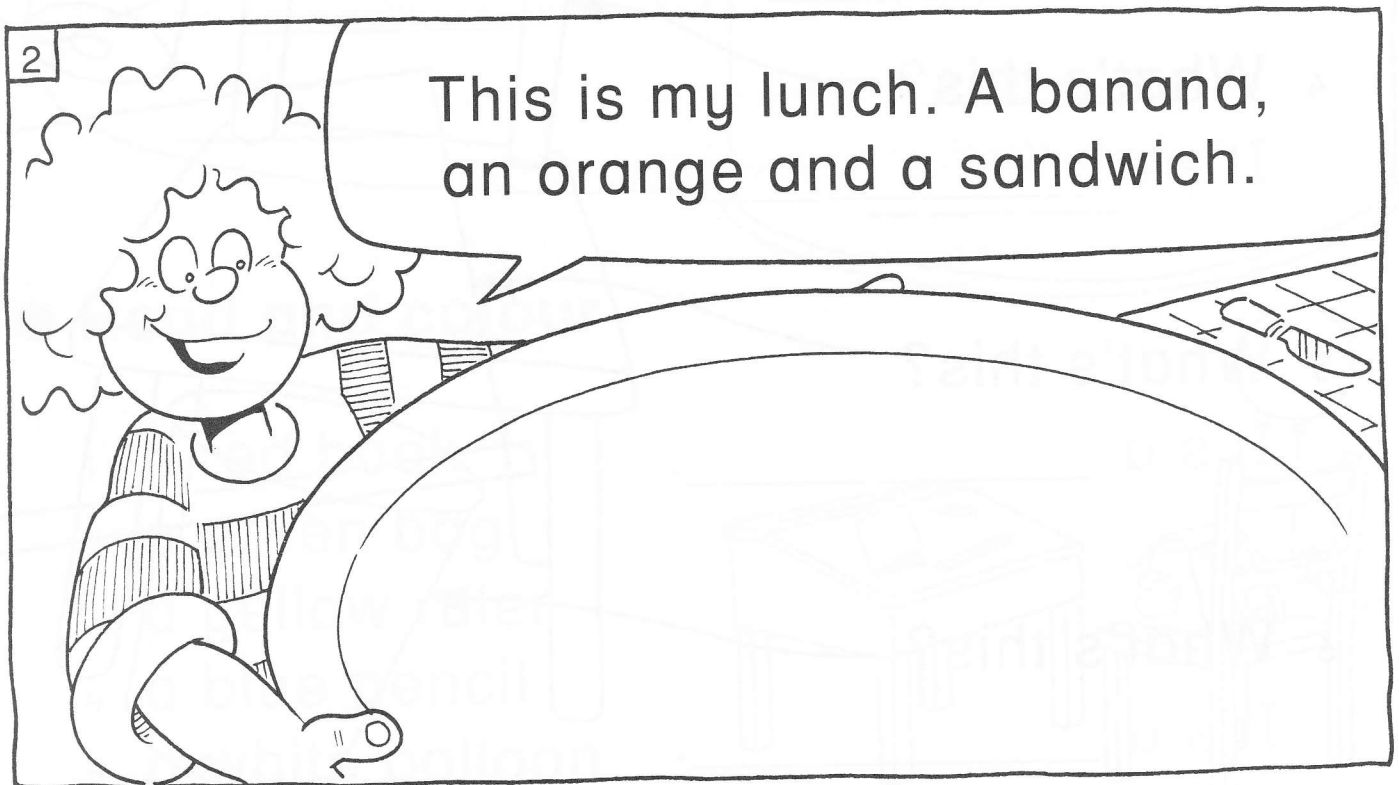
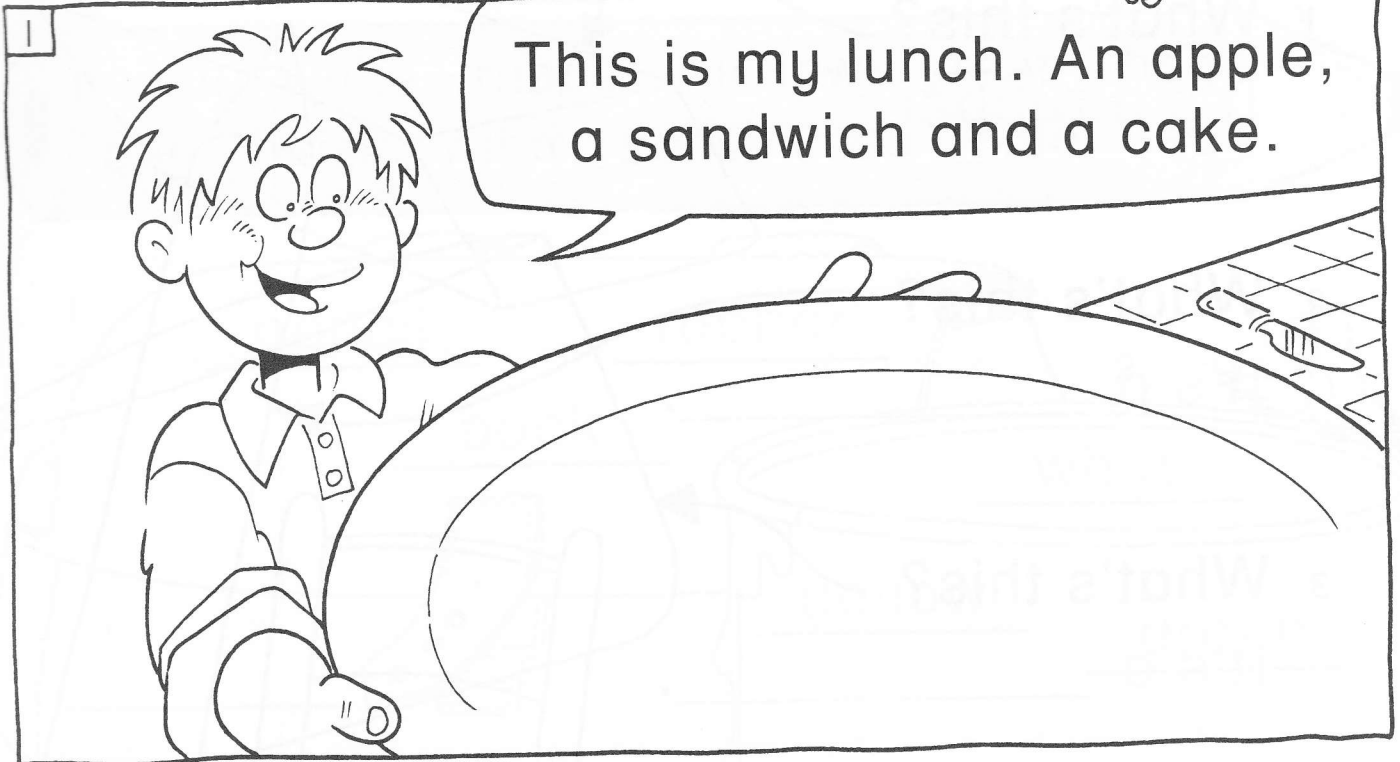
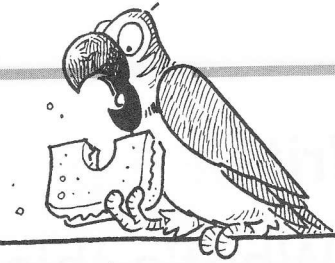

● Match and write

1



2



3



4



5

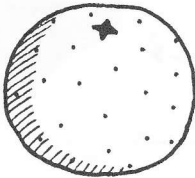

6

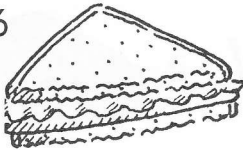

7

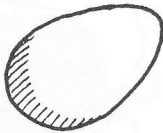

an apple

a banana

a cake

an egg

a sandwich

an ice cream

an orange

● Odd one out

o a o o \_

l l l i \_

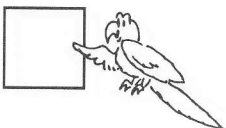

● Draw and write about your lunch

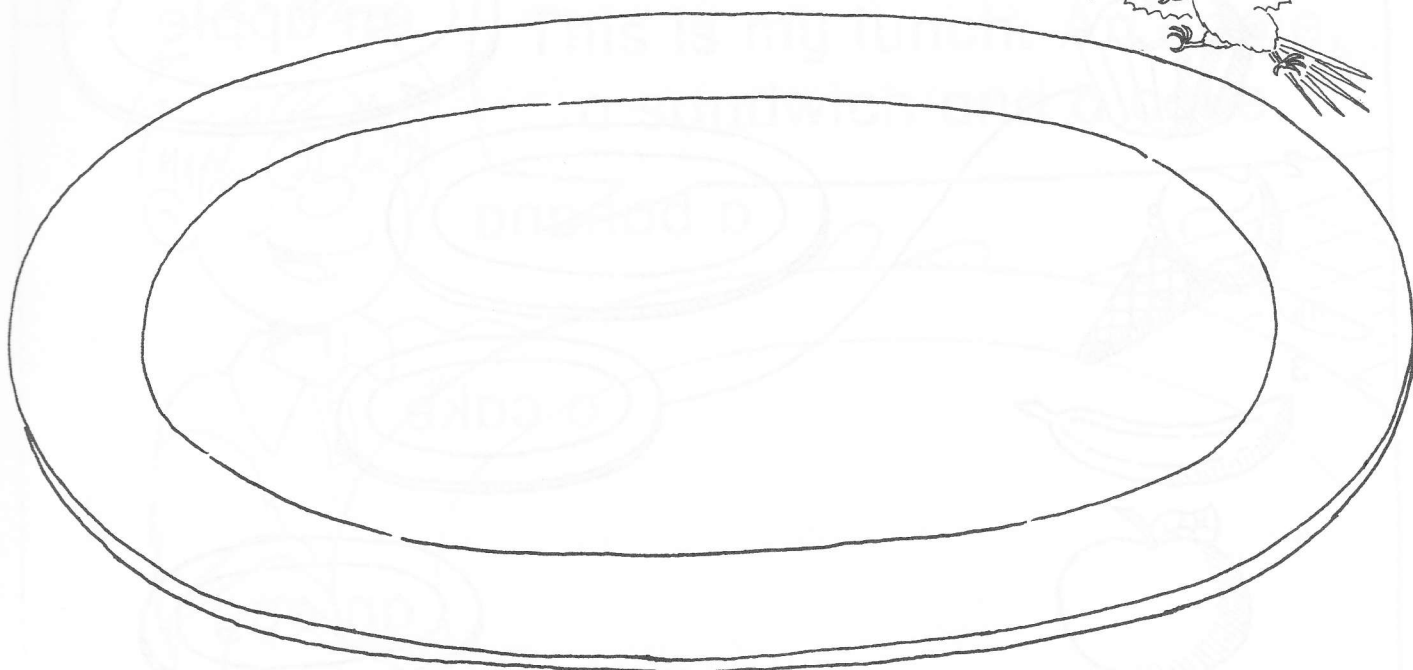

This is my lunch. A \_\_\_\_\_,  
a \_\_\_\_\_ and \_\_\_\_\_.

● Match and write

a  
o  
e

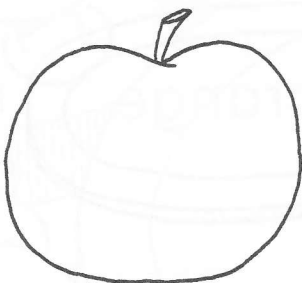

a  
i  
o

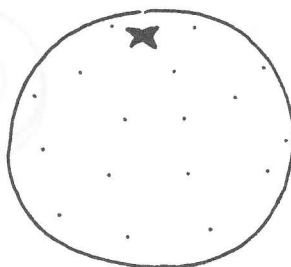

e  
a  
i





● Write

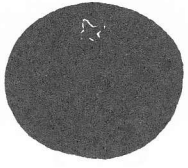

1 What's this? It's an orange.

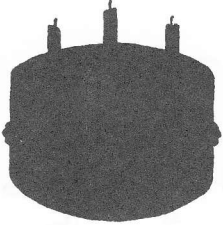

2 What's this? It's a cake.



3 What's this? It's \_\_\_\_\_.



4 What's this? It's \_\_\_\_\_.



5 What's this? It's \_\_\_\_\_.

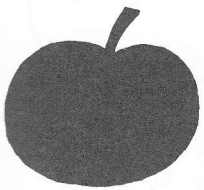

6 What's this? It's \_\_\_\_\_.

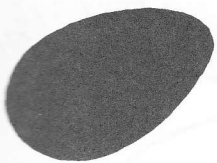

7 What's this? It's \_\_\_\_\_.



● Draw

1

one

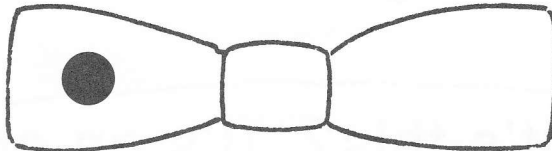

2

two



3

three



4

four

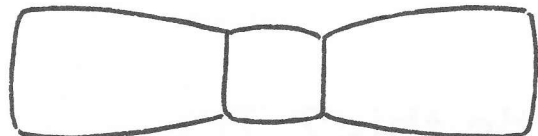

5

five

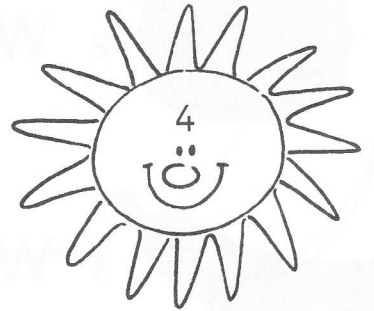
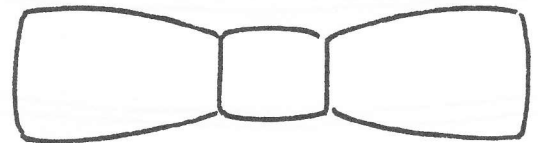

● Colour

one = red  
 two = blue  
 three = green  
 four = yellow  
 five = black

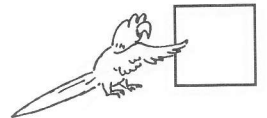
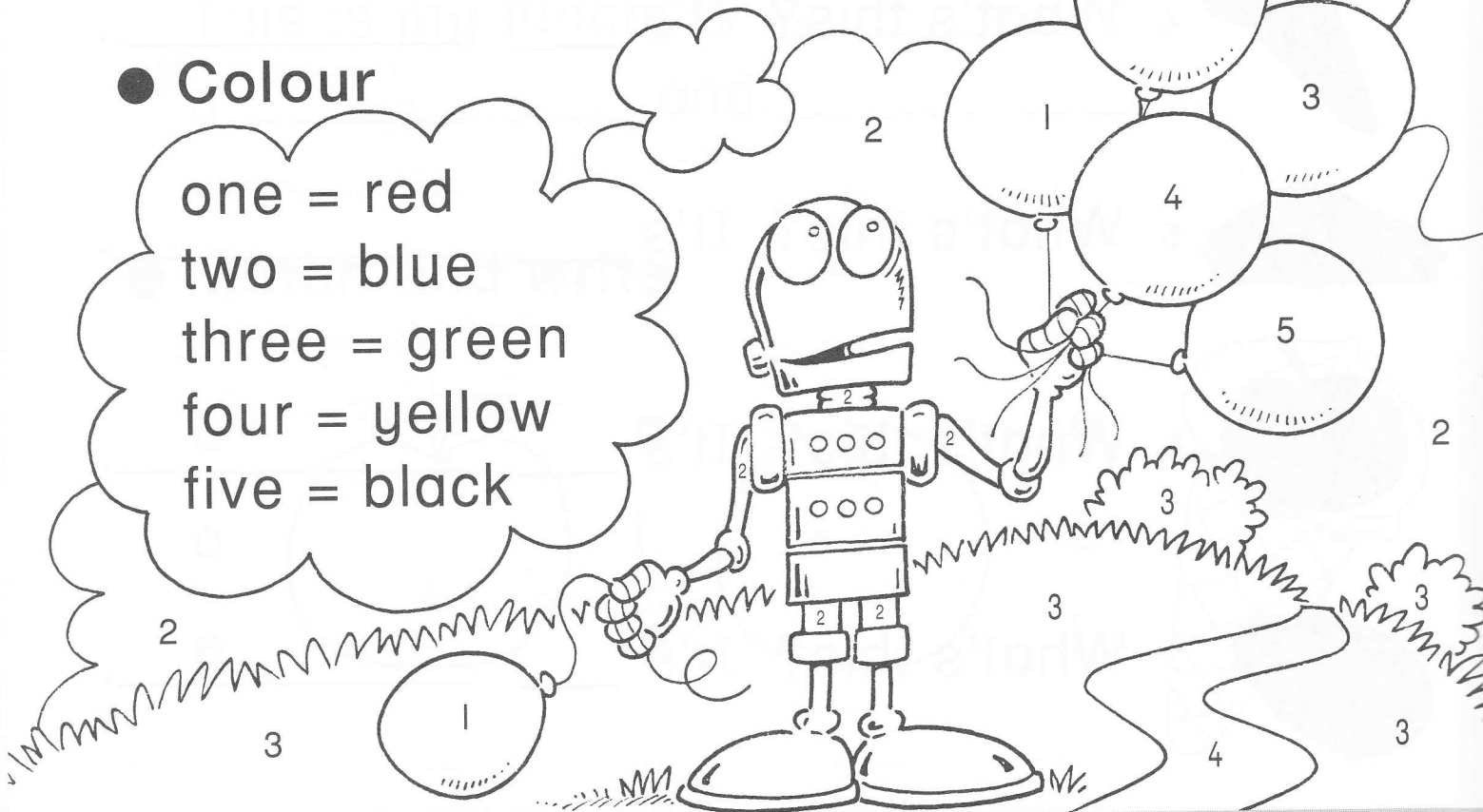

● Count and colour

one

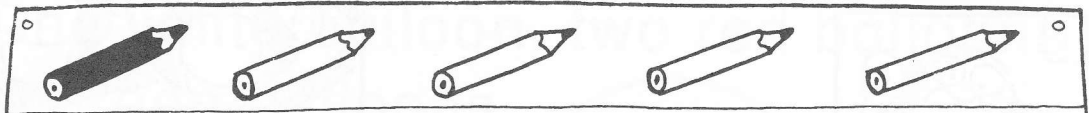

two

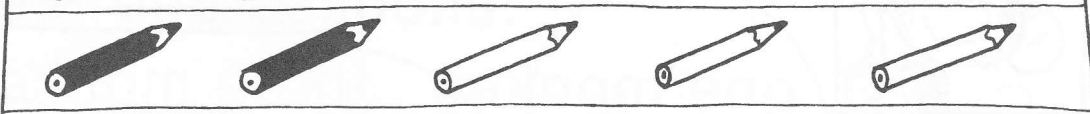

three

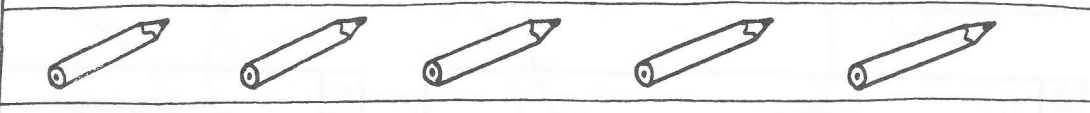

four

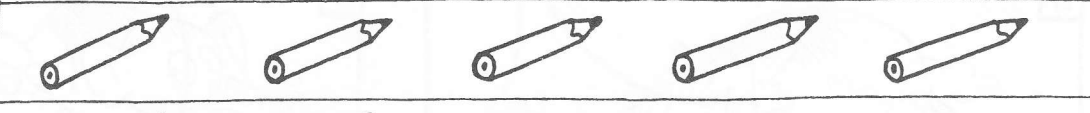

five

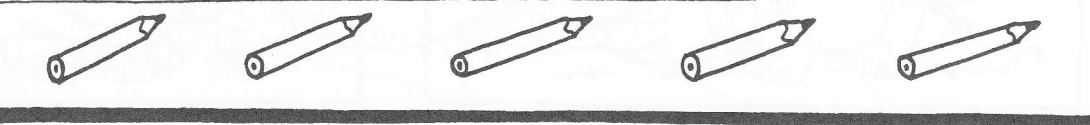

● Count and write

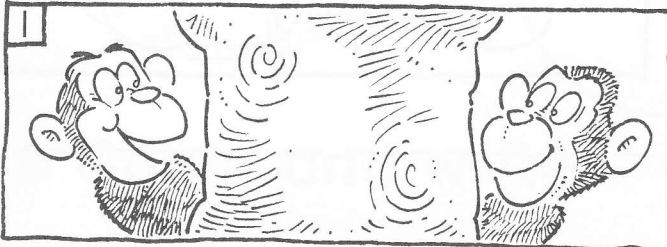

How many monkeys?

two

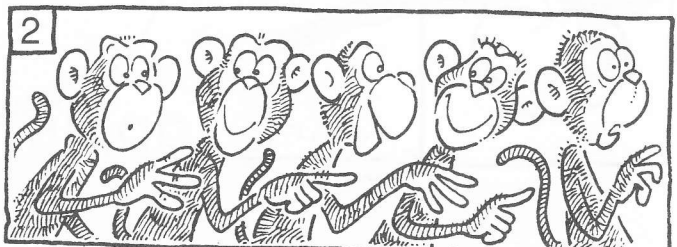

How many monkeys?

\_\_\_\_\_



How many monkeys?

\_\_\_\_\_



How many monkeys?

\_\_\_\_\_

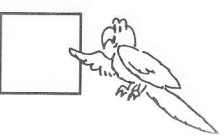

● Count and write

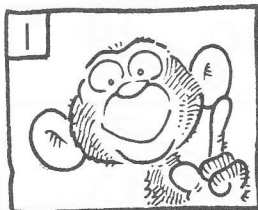

one monkey    three monkeys

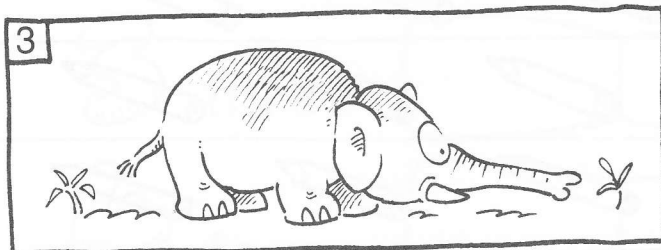
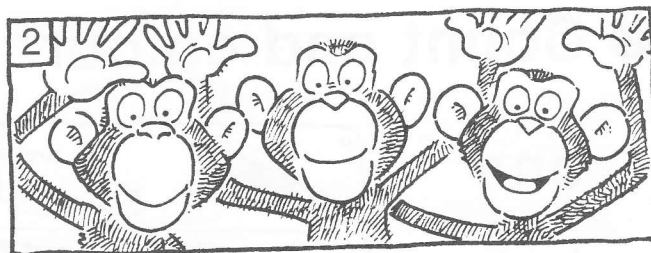

one elephant

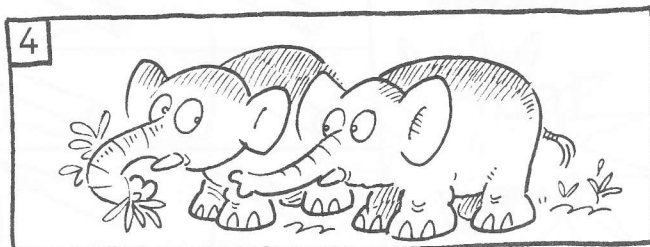

two \_\_\_\_\_

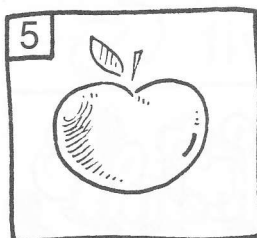

\_\_\_\_\_ apple

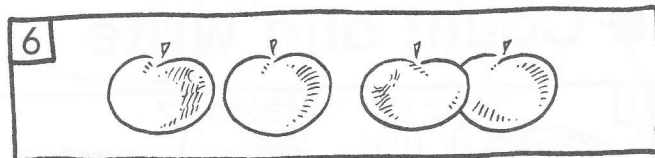

\_\_\_\_\_

● Match and write

e  
a  
l

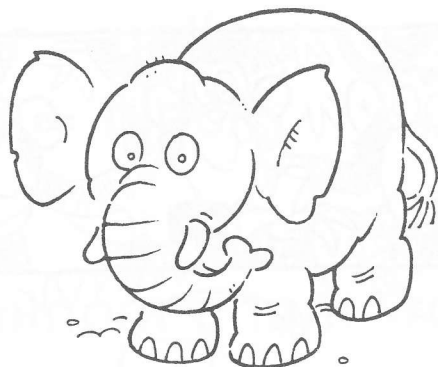

n  
e  
m



t  
f  
o

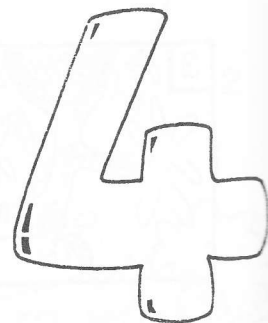



● Read and colour

Look. One white balloon, two red balloons and two green balloons.

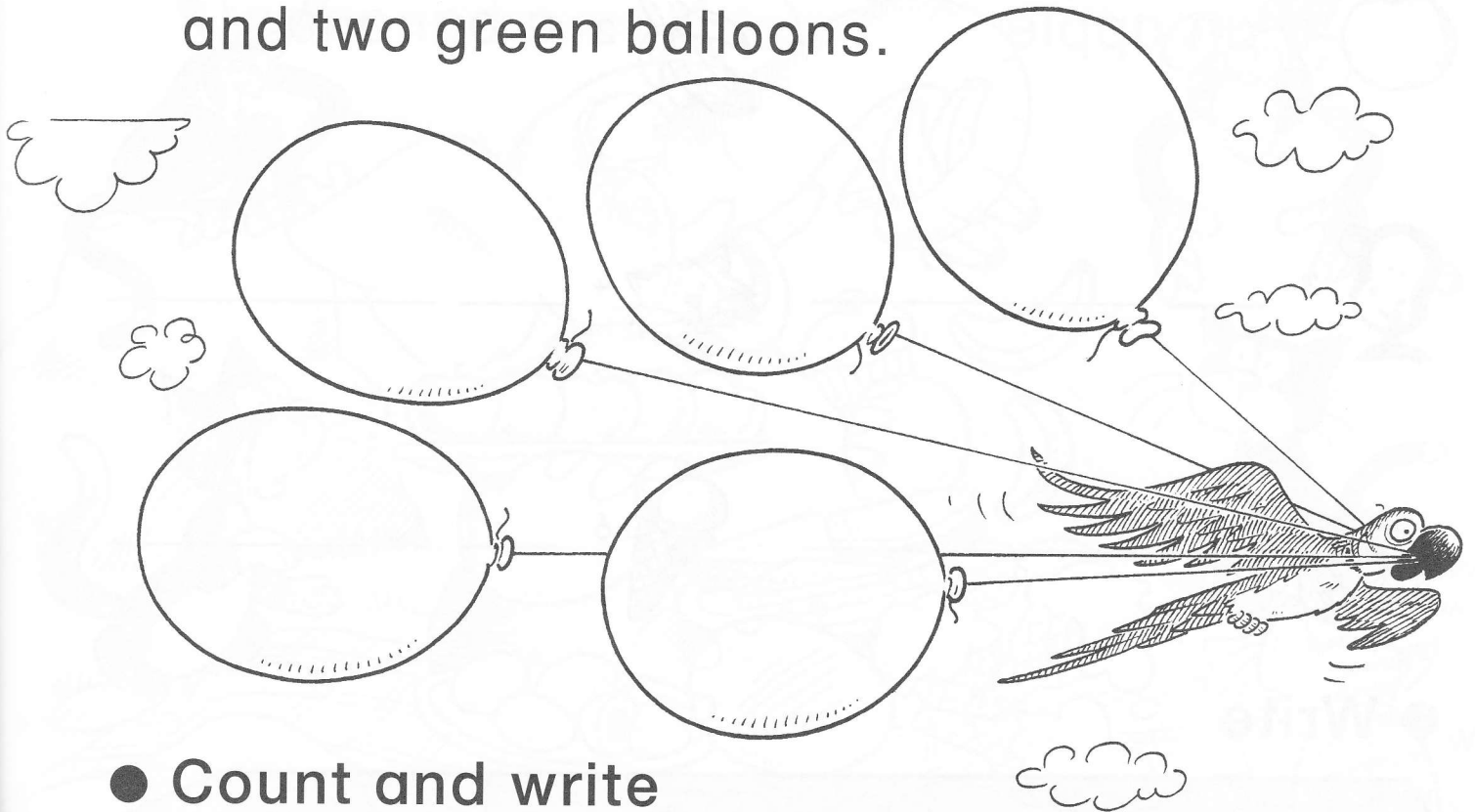

● Count and write

- 1 How many green balloons? two
- 2 How many white balloons? \_\_\_\_\_
- 3 How many red balloons? \_\_\_\_\_
- 4 How many balloons? \_\_\_\_\_

● Odd one out

t t f t \_

o o o e \_

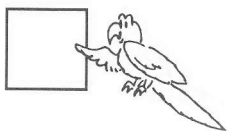

● Write

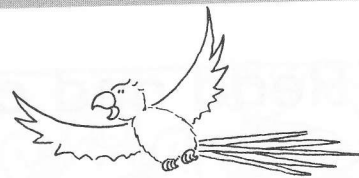

1 an apple



2 a banana



3 \_\_\_\_\_



4 \_\_\_\_\_



5 \_\_\_\_\_



6 \_\_\_\_\_

● Write

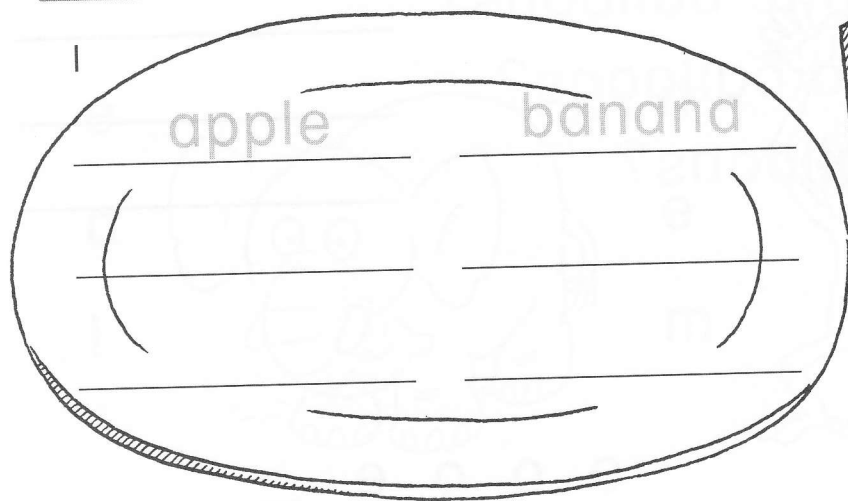
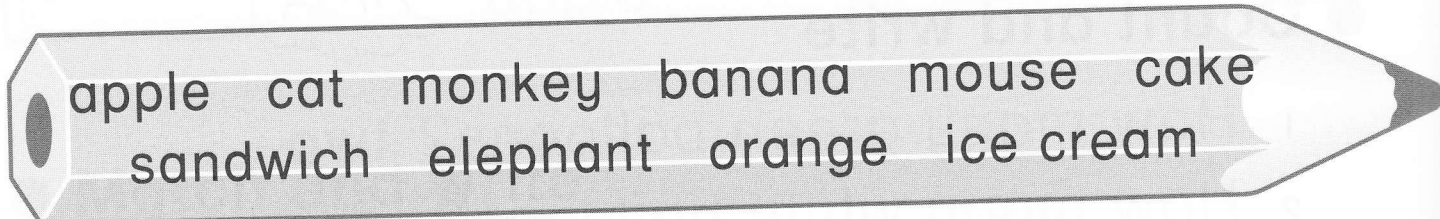

apple banana

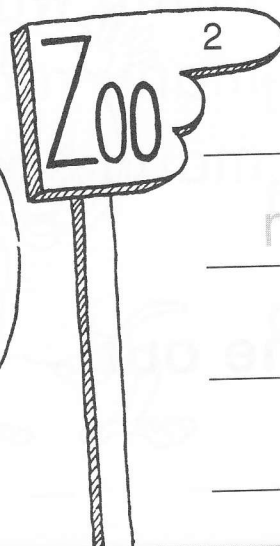

cat

monkey



● Count and write

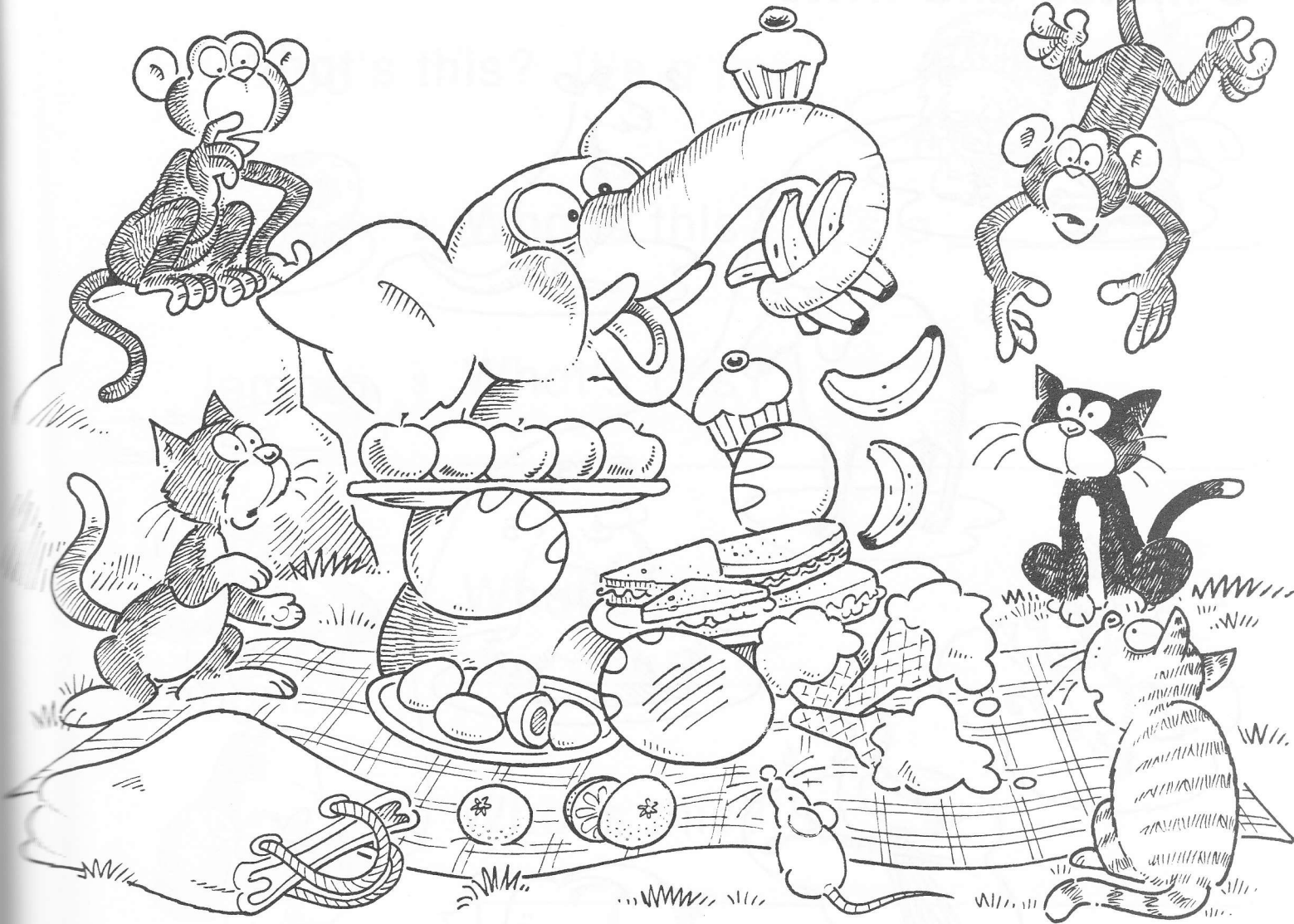

one elephant \_\_\_\_\_

three cats \_\_\_\_\_

\_\_\_\_\_ bananas \_\_\_\_\_

\_\_\_\_\_ mouse \_\_\_\_\_

\_\_\_\_\_ oranges \_\_\_\_\_

\_\_\_\_\_ apples \_\_\_\_\_

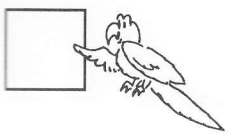

● Match and write

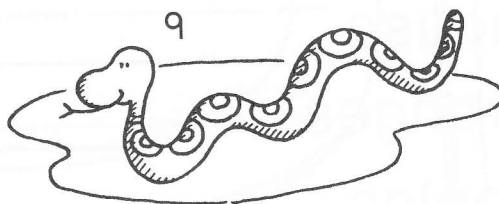
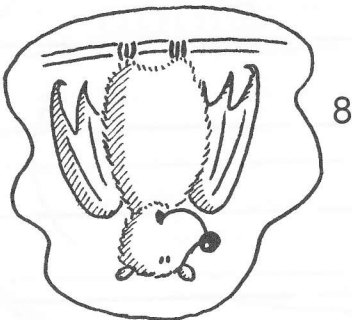
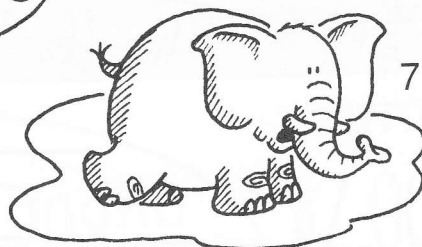
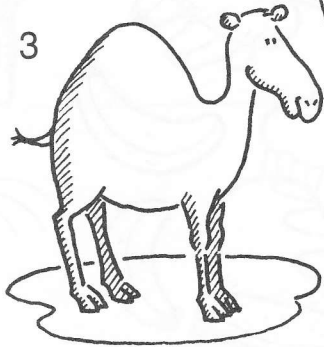
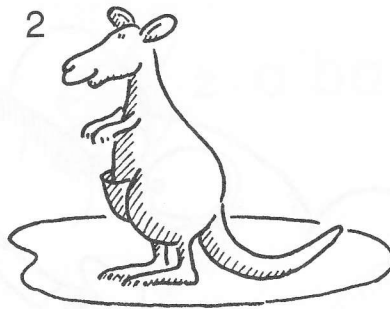
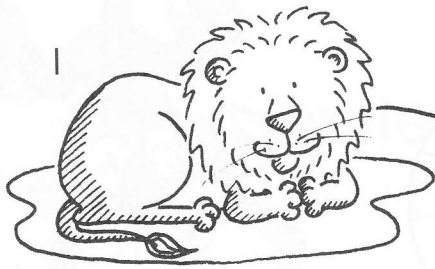

bat

bear

camel

elephant

kangaroo

lion

monkey

parrot

snake

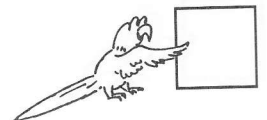

● Write

1 What's this? It's a lion.

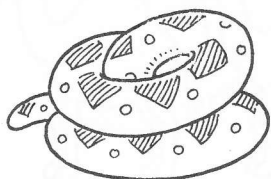

2 What's this? It's a \_\_\_\_\_.



3 What's this?  
\_\_\_\_\_

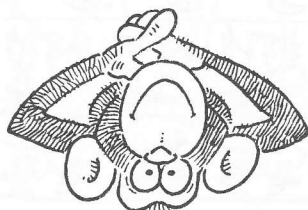

4 What's this?  
\_\_\_\_\_



5 What's this?  
\_\_\_\_\_



6 What's this?  
\_\_\_\_\_



7 What's this?  
\_\_\_\_\_

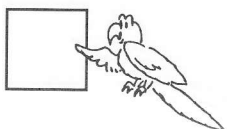



● Match and write

6      7      8      9      10  
 nine   ten   six   eight   seven

● Count and colour

three

eight

six

nine

ten

seven

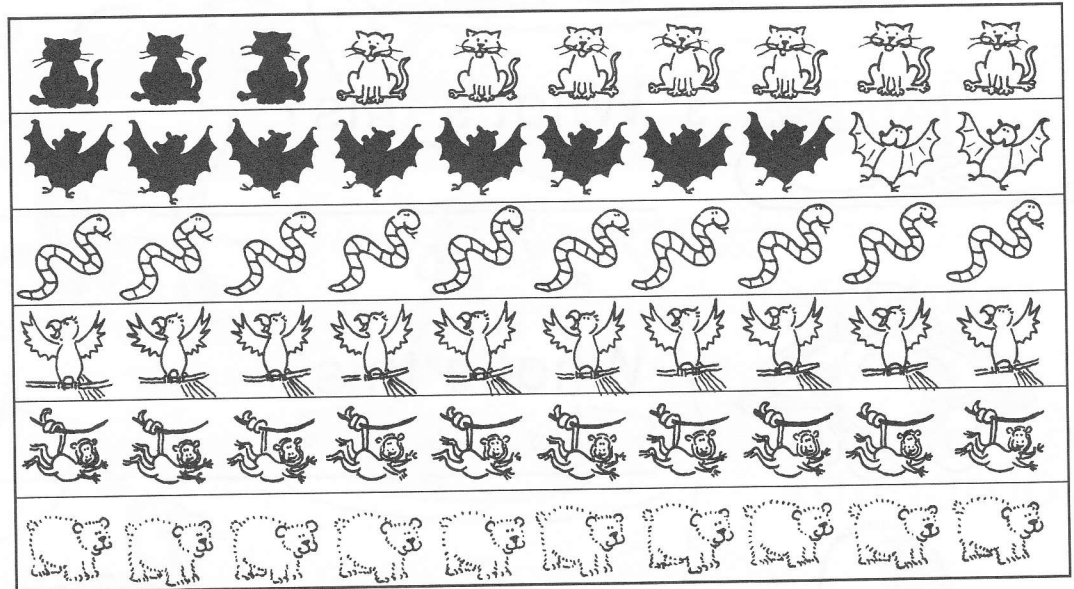

● Match and write

l  
n  
t

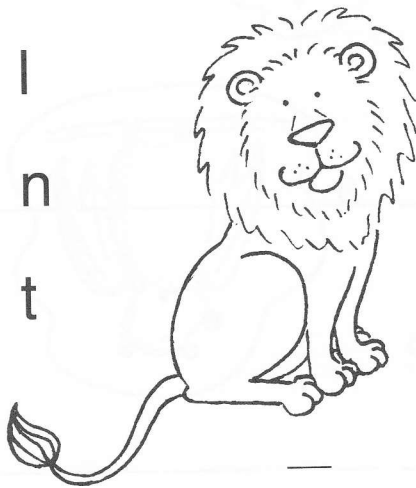

s  
z  
o



k  
g  
c

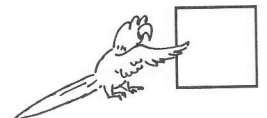
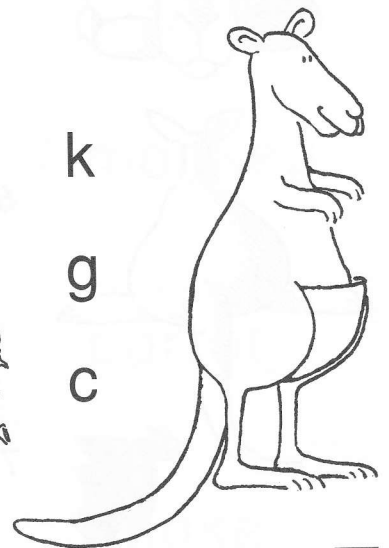

● Count and write

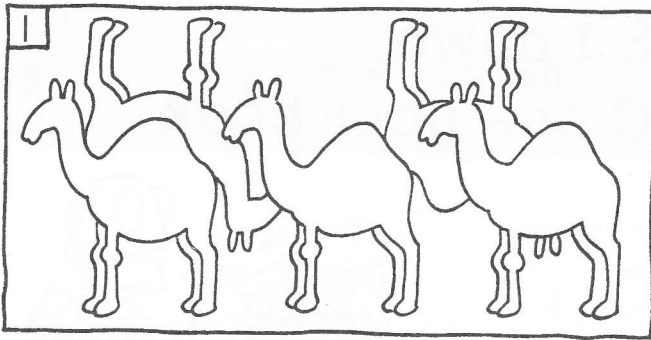

five camels

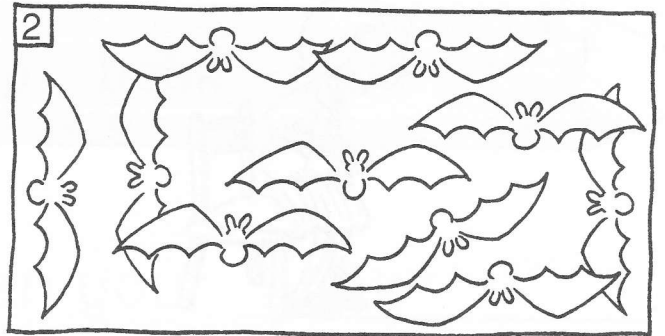

\_\_\_\_\_ bats

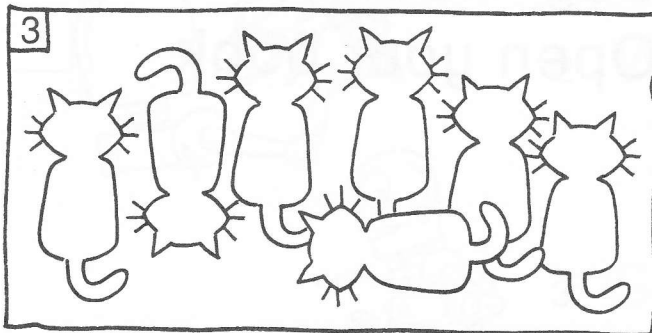

\_\_\_\_\_ cats

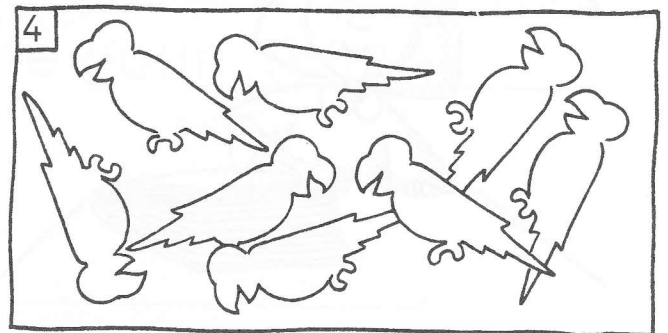

\_\_\_\_\_

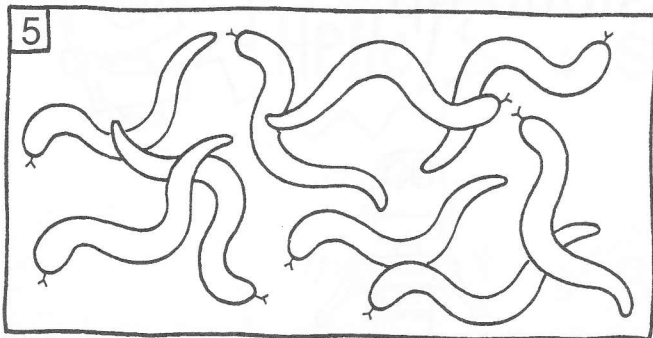

\_\_\_\_\_

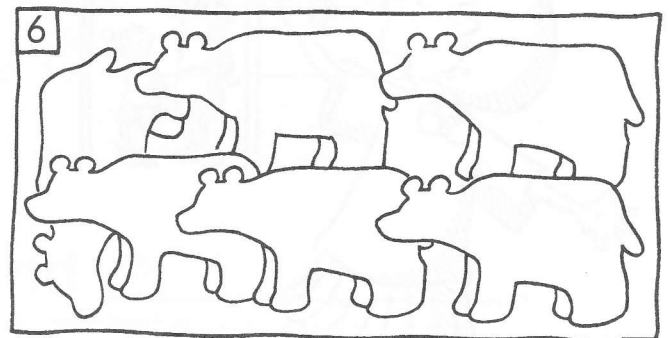

\_\_\_\_\_

● Odd one out

x k x x \_

s s z s \_

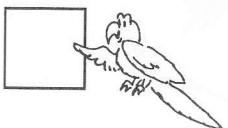
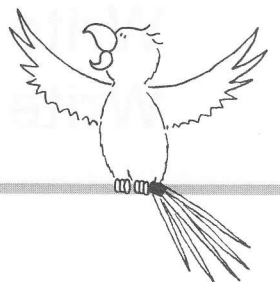

● Tick ✓

1



Sit down.



Close your book.



2



Say 'Hello'.



Open your book.



3



Say 'Goodbye'.



Stand up.



● Write

Write 'Hello'.

Hello

Write 'Goodbye'.

\_\_\_\_\_

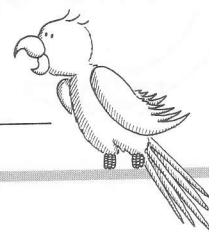

● Write

name 'Hello' up book down

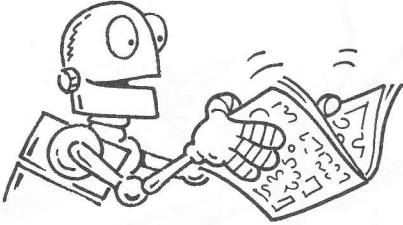

1 Open your book.

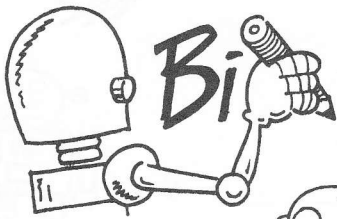

2 Write your name.

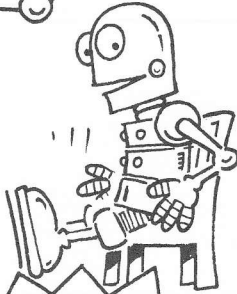

3 Sit \_\_\_\_\_.



4 Say \_\_\_\_\_.

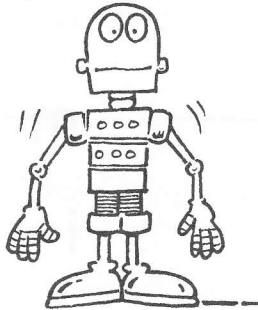

5 Stand \_\_\_\_\_.

● Odd one out

o o o c \_

m n m m \_

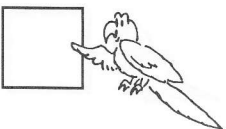

● Draw and write

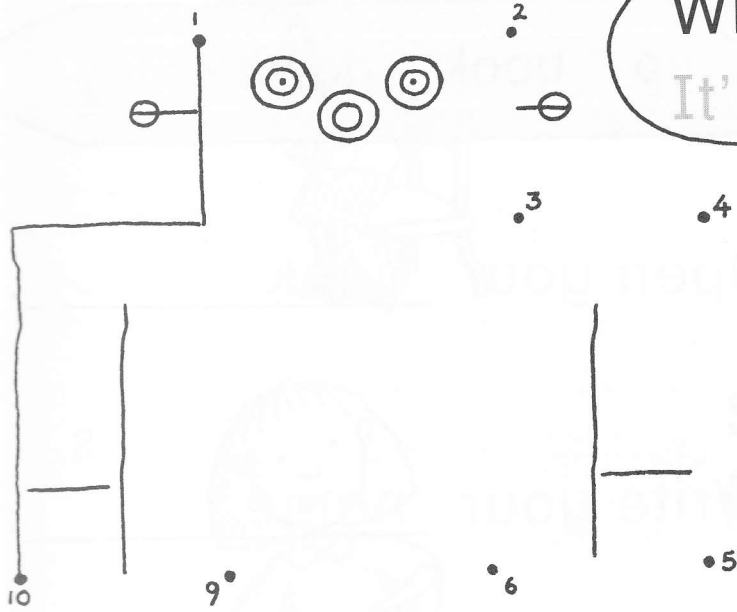

What's this?  
It's a \_\_\_\_\_.



● Match and write

t  
s  
c



c  
o  
s



m  
i  
n



\_\_\_\_\_



● Write

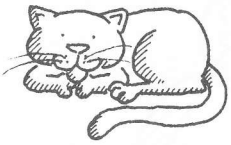

1 cat

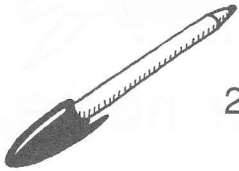

2 \_\_\_\_\_

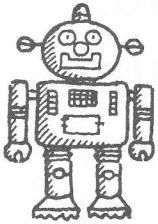

3 \_\_\_\_\_



4 \_\_\_\_\_

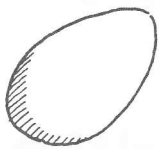

5 \_\_\_\_\_



6 \_\_\_\_\_



7 \_\_\_\_\_

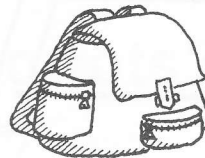

8 \_\_\_\_\_

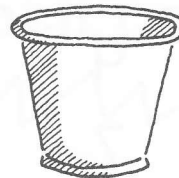

9 \_\_\_\_\_

c	a	t	p	e	n
x	r	o	b	o	t
p	i	l	i	o	n
e	g	g	b	a	t
s	c	a	k	e	c
b	a	g	b	i	n

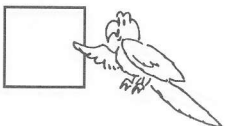



● Write

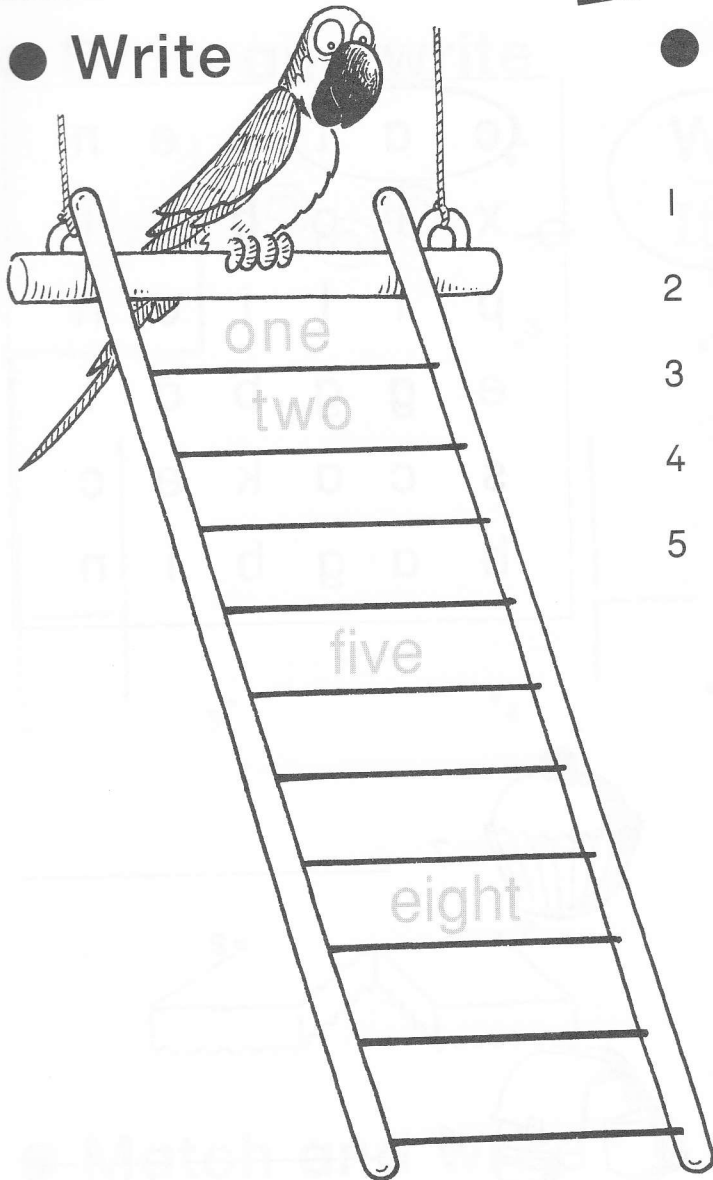

● Match and write

- 1 Say up.
- 2 Sit your book.
- 3 Open 'Hello'.
- 4 Stand your name.
- 5 Write down.

● Odd one out

- |      |     |     |     |            |
|------|-----|-----|-----|------------|
| 3    | 8   | 3   | 3   | <u>8</u>   |
| 6    | 6   | 6   | 9   | —          |
| 7    | 7   | 1   | 7   | —          |
| two  | two | ten | two | <u>ten</u> |
| nine | one | one | one | —          |



● Read and colour

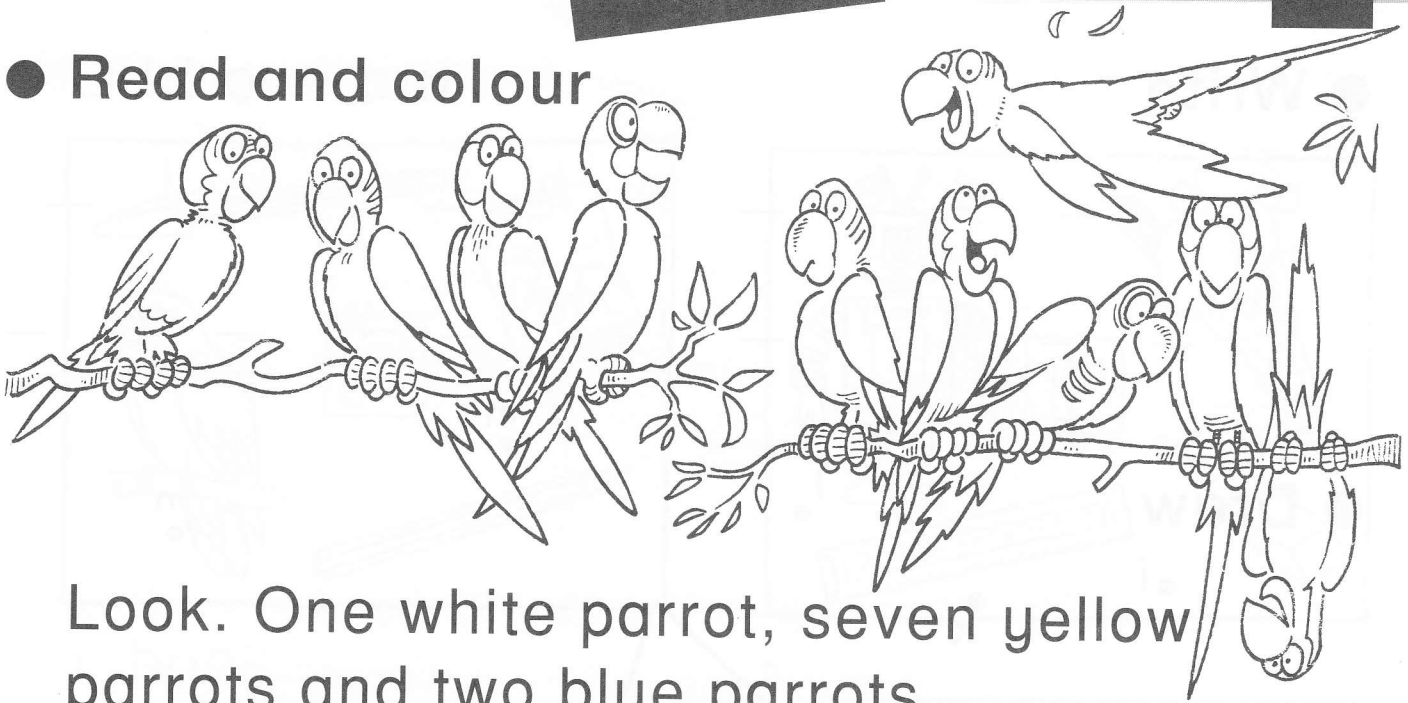

Look. One white parrot, seven yellow parrots and two blue parrots.

● Count and write

- 1 How many yellow parrots?
- 2 How many blue parrots?
- 3 How many white parrots?
- 4 How many parrots?

seven

---



---



---

● Write about your pencil case

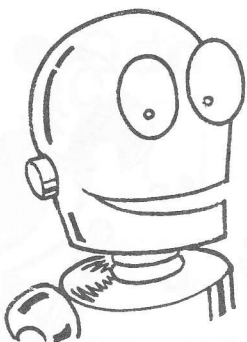

How many pencils?

---

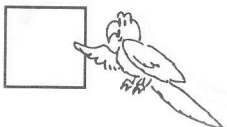

● Write

a b \_ d e \_ g h \_ j k l \_  
n \_ \_ q r \_ t u \_ w \_ y \_

m

l

n

● Draw

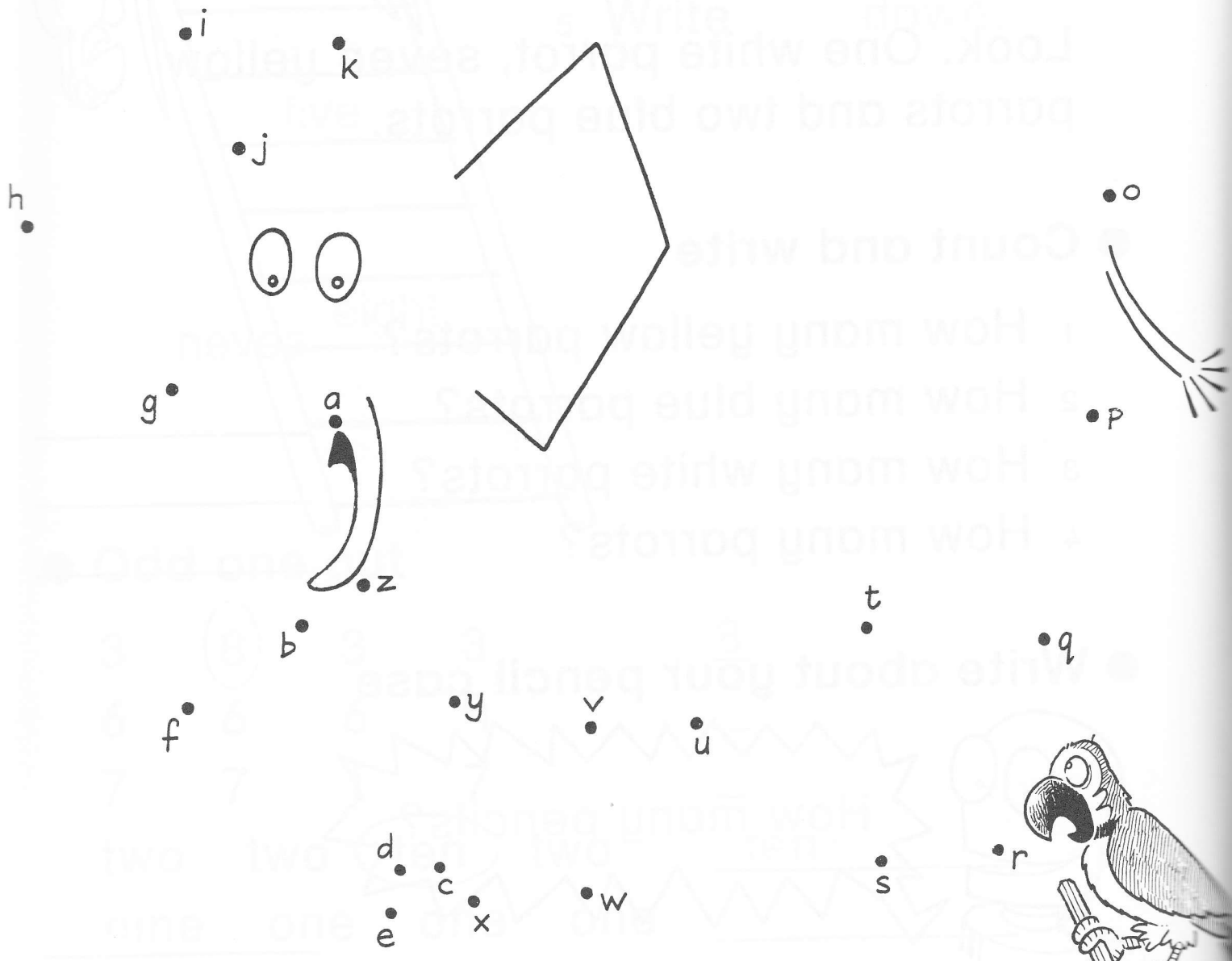

● Odd one out

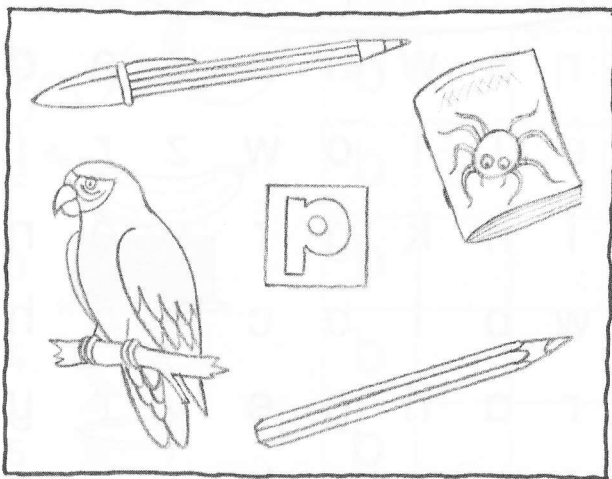

1 book

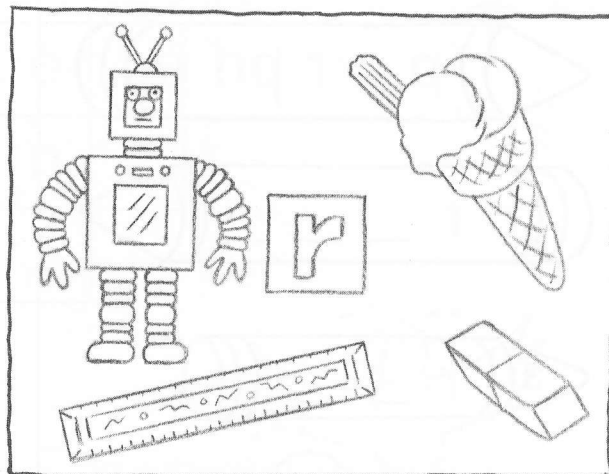

2

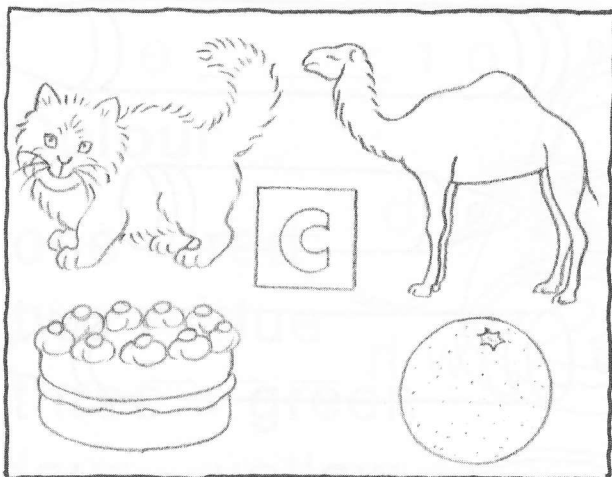

3

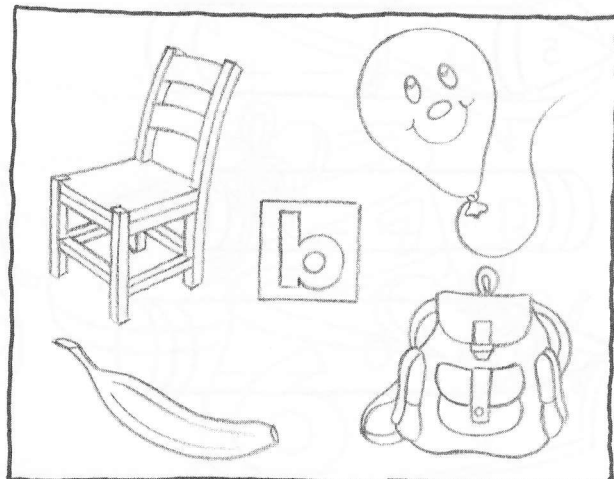

4

● Odd one out

j i j j —

p p p q —

u u v u —

y g g g —

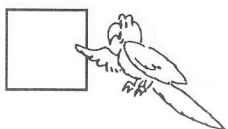

● Write

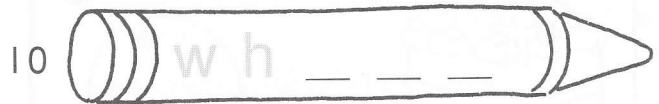
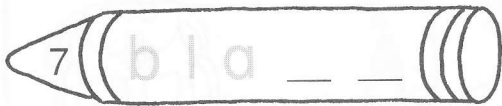
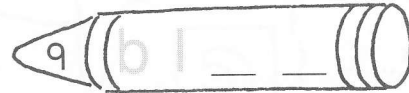
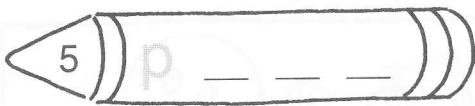
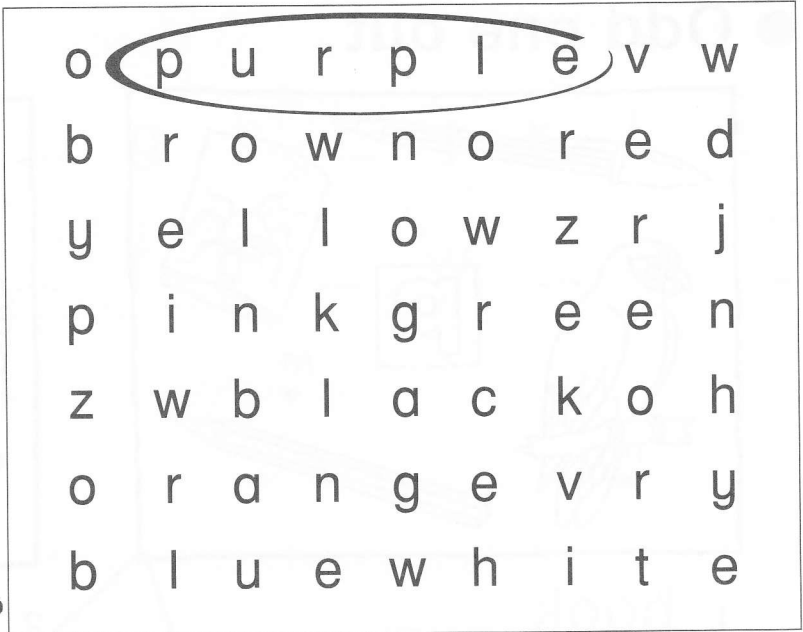
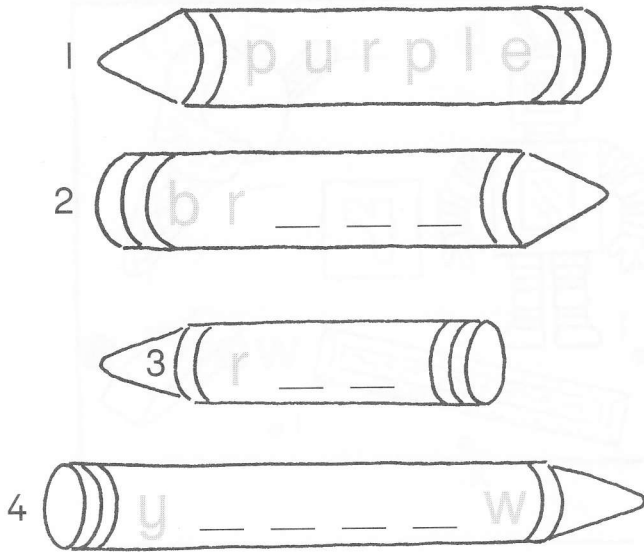

● Write

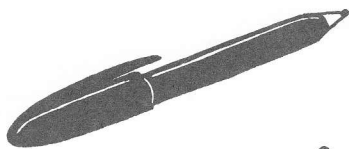

1 Is it a black pen?

Yes, it is.

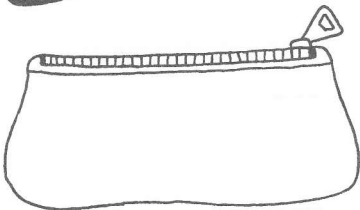

2 Is it a black pencil case?

\_\_\_\_\_ , \_\_\_\_\_ .



● Write

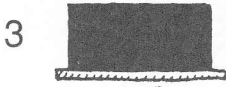
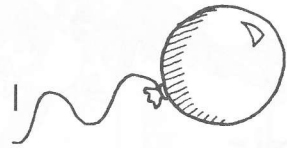

b	a	i	i	o	o	n
b	a	n	a	n	a	
b						
b						
b						
b						



● Colour

- one = red
- two = blue
- three = green
- four = yellow
- five = black
- six = white
- seven = orange
- eight = brown

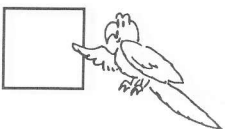
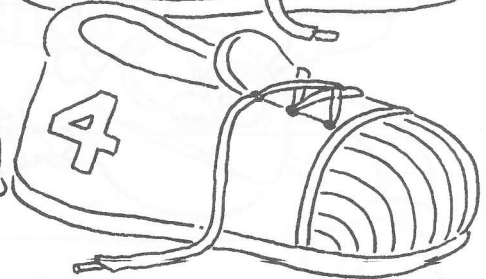
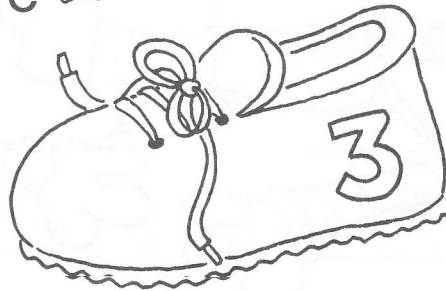
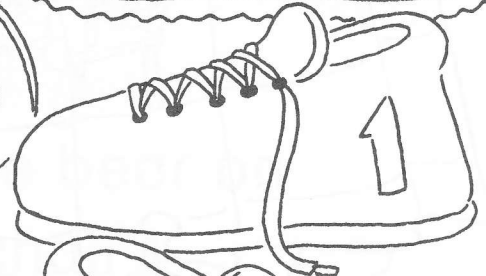
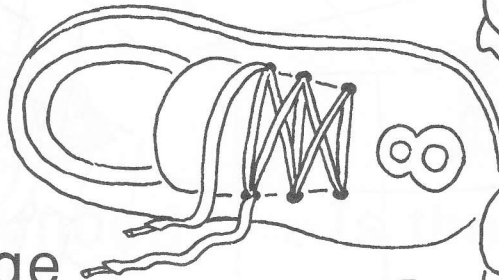



● Read and colour

- 1 The black robot is in the bed.
- 2 The orange robot is on the chair.
- 3 The brown robot is under the bed.
- 4 The green robot is under the chair.

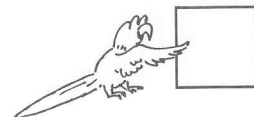
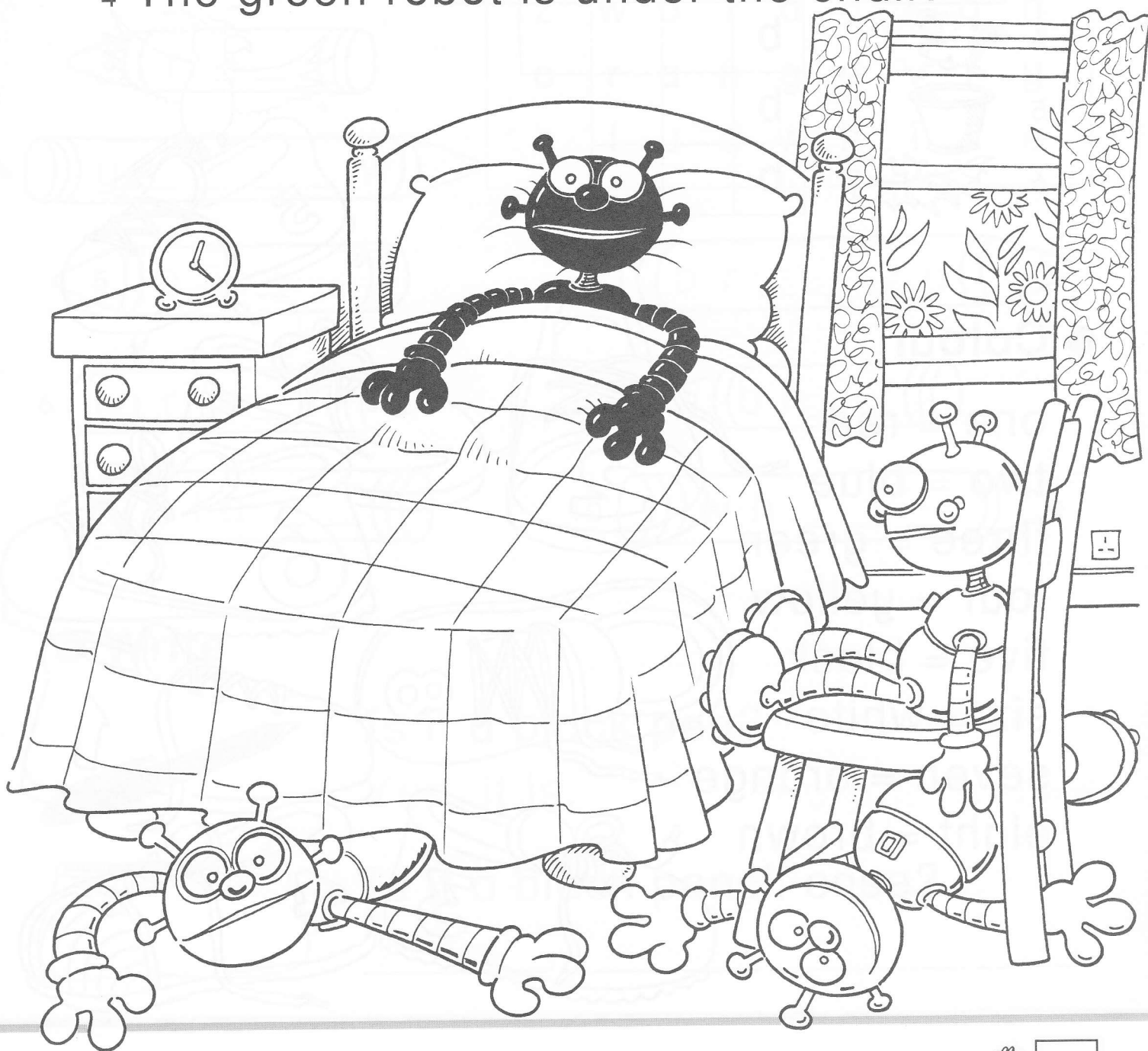

● Write

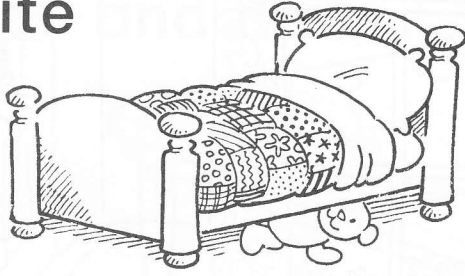

1 Is the bear under the bed?

Yes, it is.

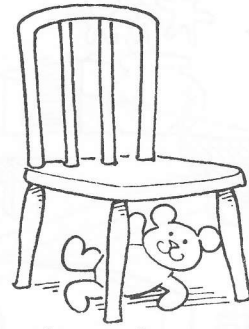

2 Is the bear on the chair?

No, it isn't.



3 Is the bear in the bin?

\_\_\_\_\_ , \_\_\_\_\_

\_\_\_\_\_ .

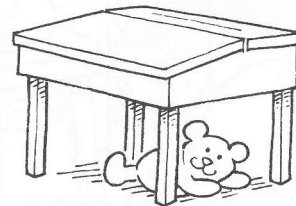

4 Is the bear on the desk?

\_\_\_\_\_ , \_\_\_\_\_

\_\_\_\_\_ .



5 Is the bear under the bed?

\_\_\_\_\_ , \_\_\_\_\_

\_\_\_\_\_ .



6 Is the bear on the chair?

\_\_\_\_\_ , \_\_\_\_\_

\_\_\_\_\_ .

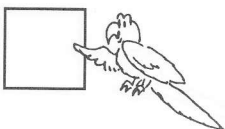

● Tick ✓

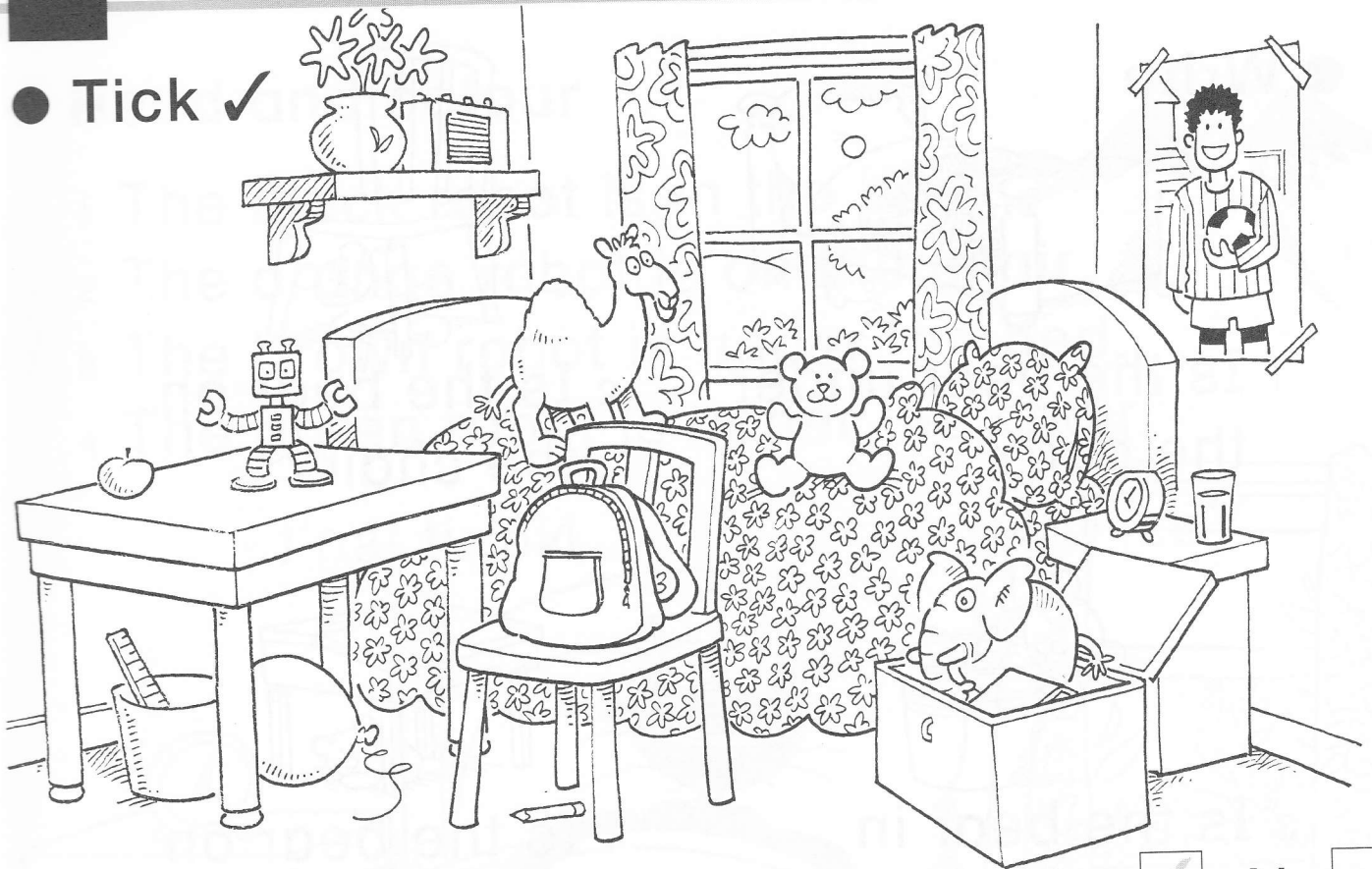

- |   |                                 |   |  |
|---|---------------------------------|---|--|
| 1 | Is the bear on the bed?         | Yes <input checked="" type="checkbox"/> | No <input type="checkbox"/>            |
| 2 | Is the pencil on the table?     | Yes <input type="checkbox"/>            | No <input checked="" type="checkbox"/> |
| 3 | Is the ruler under the bed?     | Yes <input type="checkbox"/>            | No <input type="checkbox"/>            |
| 4 | Is the book in the bin?         | Yes <input type="checkbox"/>            | No <input type="checkbox"/>            |
| 5 | Is the apple under the chair?   | Yes <input type="checkbox"/>            | No <input type="checkbox"/>            |
| 6 | Is the elephant in the box?     | Yes <input type="checkbox"/>            | No <input type="checkbox"/>            |
| 7 | Is the balloon under the table? | Yes <input type="checkbox"/>            | No <input type="checkbox"/>            |
| 8 | Is the robot on the chair?      | Yes <input type="checkbox"/>            | No <input type="checkbox"/>            |

● Colour the **b** words green

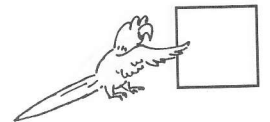

● Read and draw

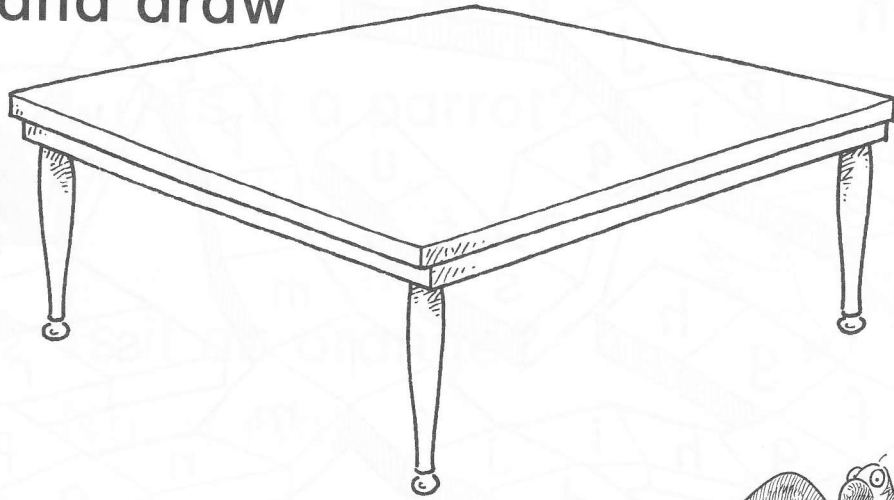

- 1 A pencil is on the table.
- 2 A pen is on the table.
- 3 A pencil case is on the table.
- 4 A bag is under the table.
- 5 A ruler is in the bag.

● Write about your pencil

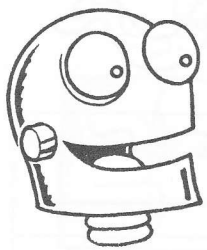

Where's your pencil? It's \_\_\_\_\_.

\_\_\_\_\_

● Odd one out

a 5 f q \_

b d 9 p \_

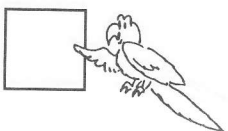

● Match

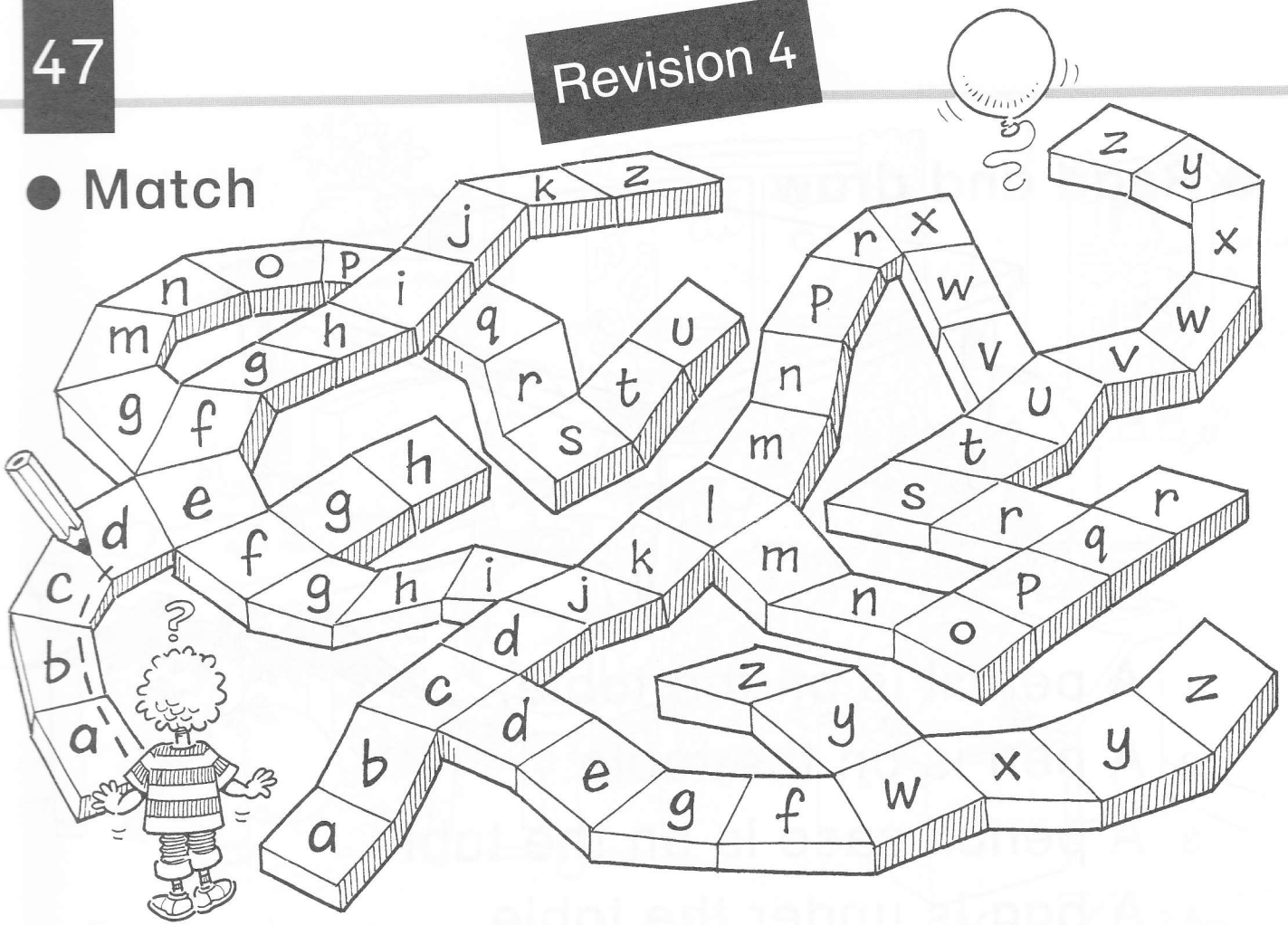

● Write



c	<u>cake</u> <u>cat</u> _____    _____
s	<u>six</u> _____    _____    _____
b	<u>bag</u> _____    _____    _____



● Write

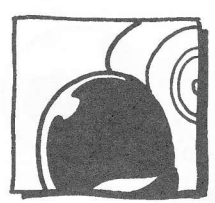

1 Is it a parrot?  
Yes, it is.

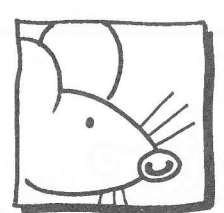
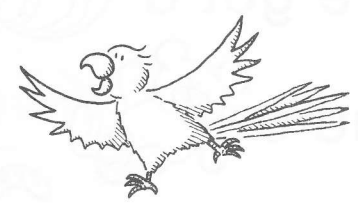

2 Is it an orange?  
No, it isn't.

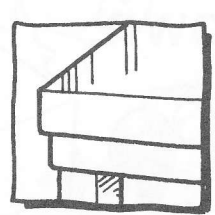

3 Is it a table?  
Yes, \_\_\_\_\_.

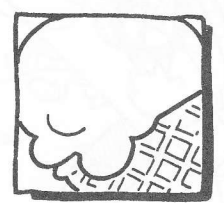

4 Is it an apple?  
\_\_\_\_\_, \_\_\_\_\_.

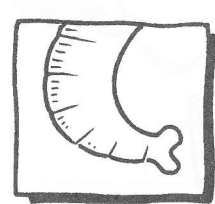

5 Is it an elephant?  
\_\_\_\_\_, \_\_\_\_\_.



6 Is it a \_\_\_\_\_?  
Yes, it is.

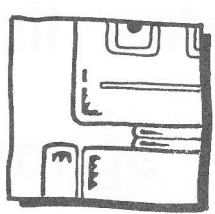

7 Is it a \_\_\_\_\_?  
Yes, it is.

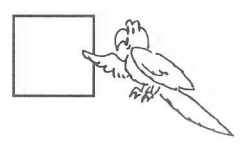



● Read and write

I've got a  ball.

And a  \_\_\_\_\_ and a  \_\_\_\_\_.

I've got a little  \_\_\_\_\_.

And my  \_\_\_\_\_'s brown.

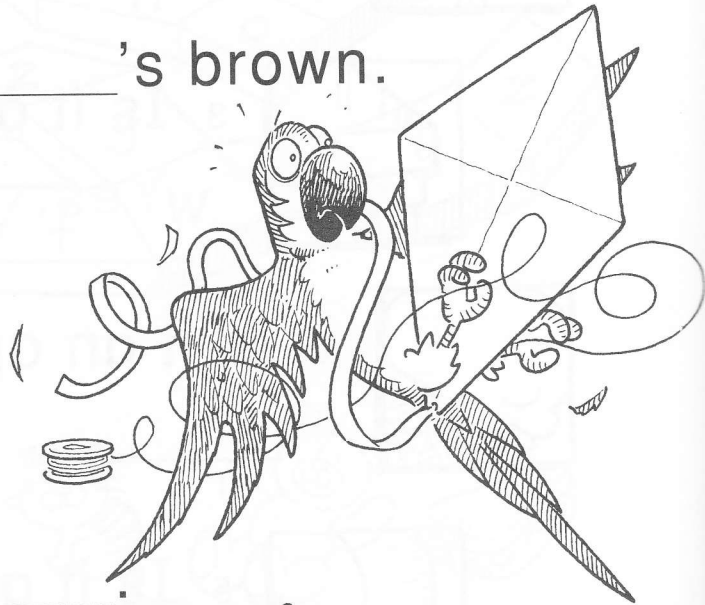

I've got a  \_\_\_\_\_.

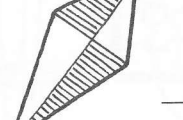
And a  \_\_\_\_\_ and a  \_\_\_\_\_.

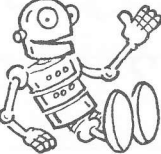
I've got a  \_\_\_\_\_.

And my  \_\_\_\_\_'s

blue and  \_\_\_\_\_.

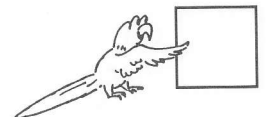

● Match and write



a balloon

a clown

a bike

a robot

a doll

a kite

a bear

a ball

● Odd one out

ball robot kite apple

apple

orange bike banana cake

\_\_\_\_\_

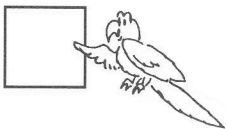

● Match and write

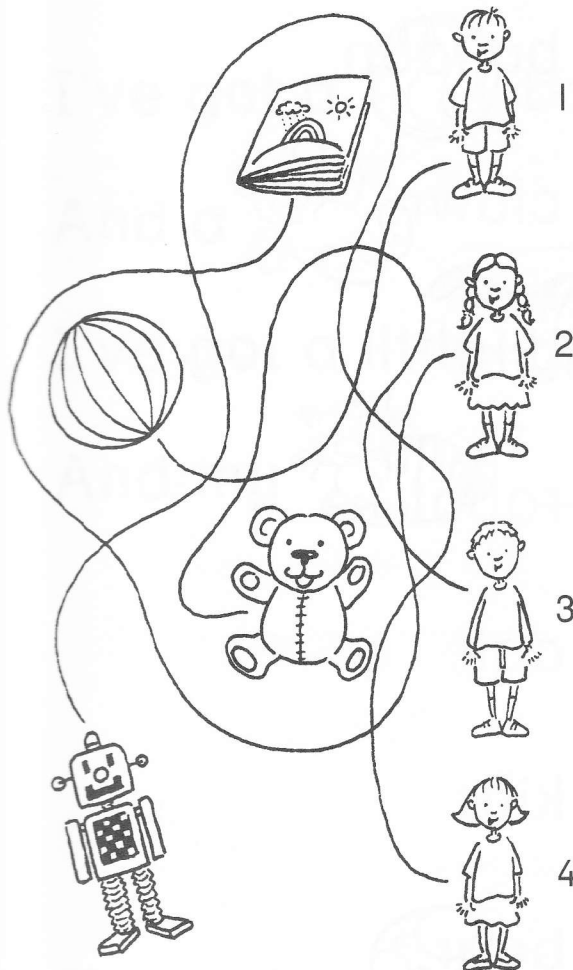

1 This is my ball.

2 This is my \_\_\_\_\_.

3 This is my \_\_\_\_\_.

4 This is my \_\_\_\_\_.

● Draw and write about your toy

This is my  
\_\_\_\_\_.

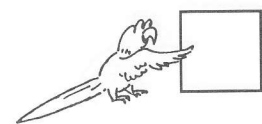

● Colour and write

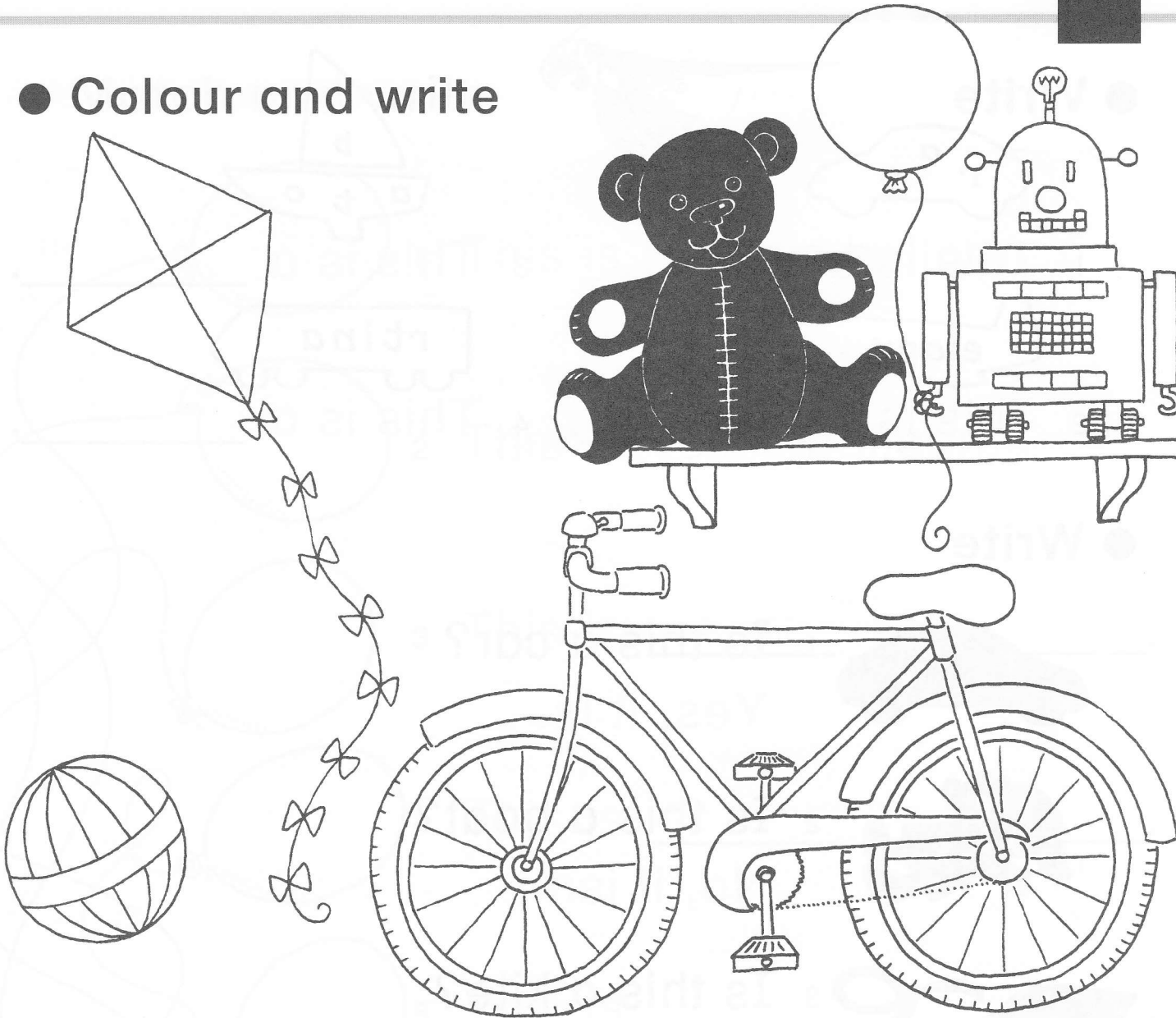

1 My bear is black.

2 My kite is \_\_\_\_\_.

3 My \_\_\_\_\_ .

4 My \_\_\_\_\_ .

5 My \_\_\_\_\_ .

6 My \_\_\_\_\_ .

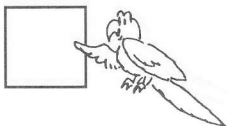

● Write



1 This is a car.

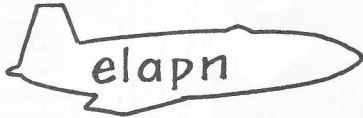

2 This is a \_\_\_\_\_.

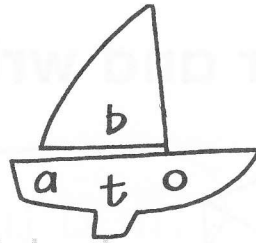

3 This is a \_\_\_\_\_.

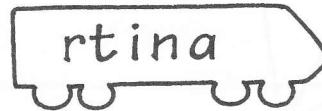

4 This is a \_\_\_\_\_.

● Write



1 Is this a car?  
Yes, it is.



2 Is this a boat?  
No, it isn't.

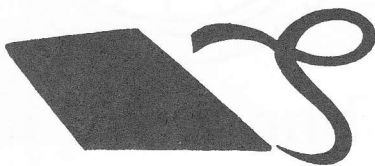

3 Is this a kite?  
\_\_\_\_\_, \_\_\_\_\_.



4 Is this a doll?  
\_\_\_\_\_, \_\_\_\_\_.

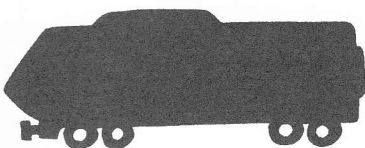

5 Is this a bike?  
\_\_\_\_\_, \_\_\_\_\_.



● Match and write



1 This is Helen's balloon.

2 This is Tom's balloon.

3 This is \_\_\_\_\_.

4 This is \_\_\_\_\_.

5 This is \_\_\_\_\_.

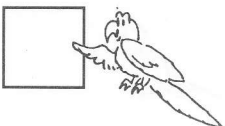
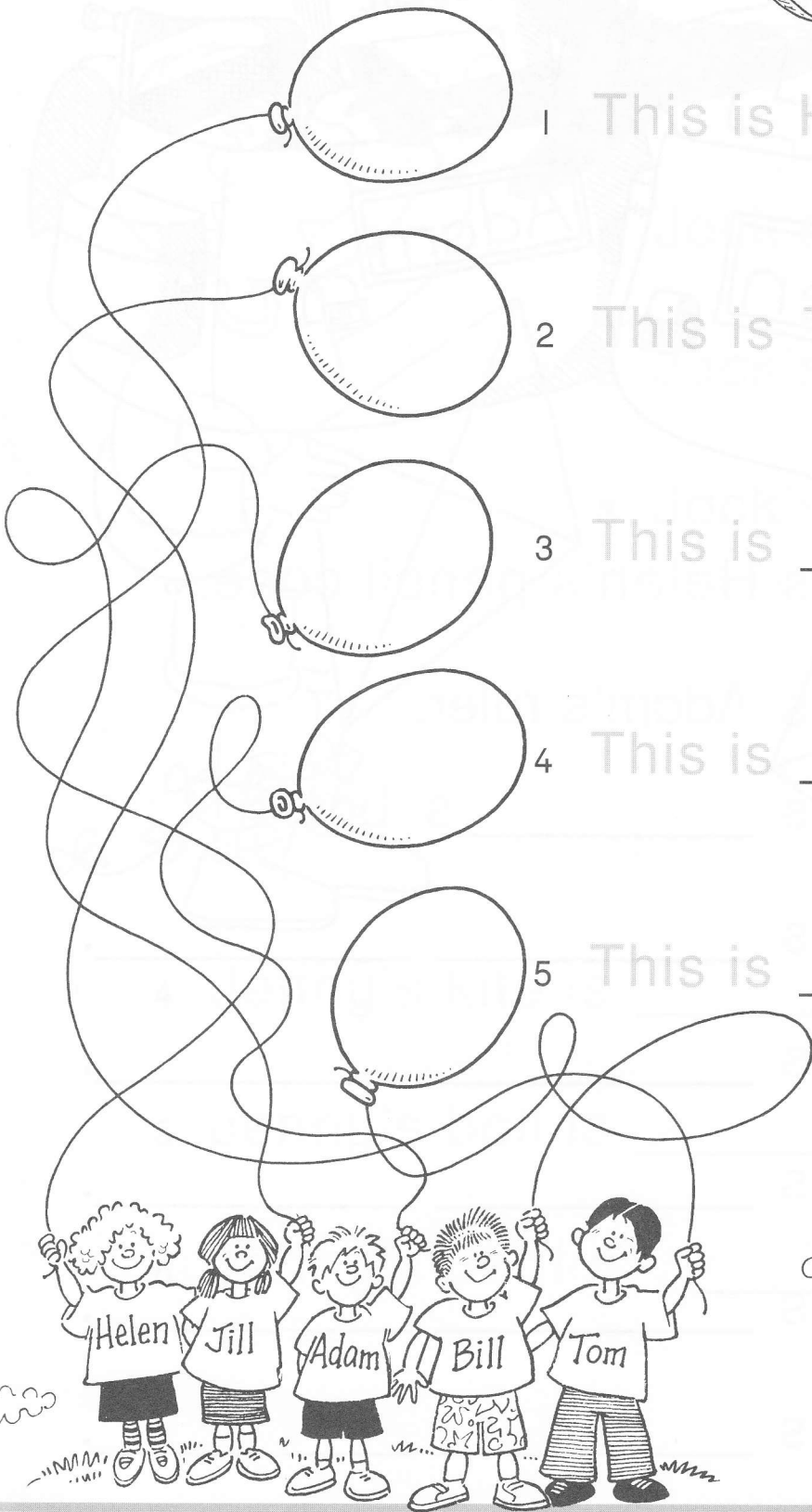



● Write

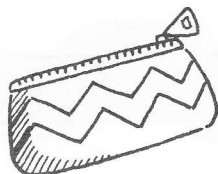
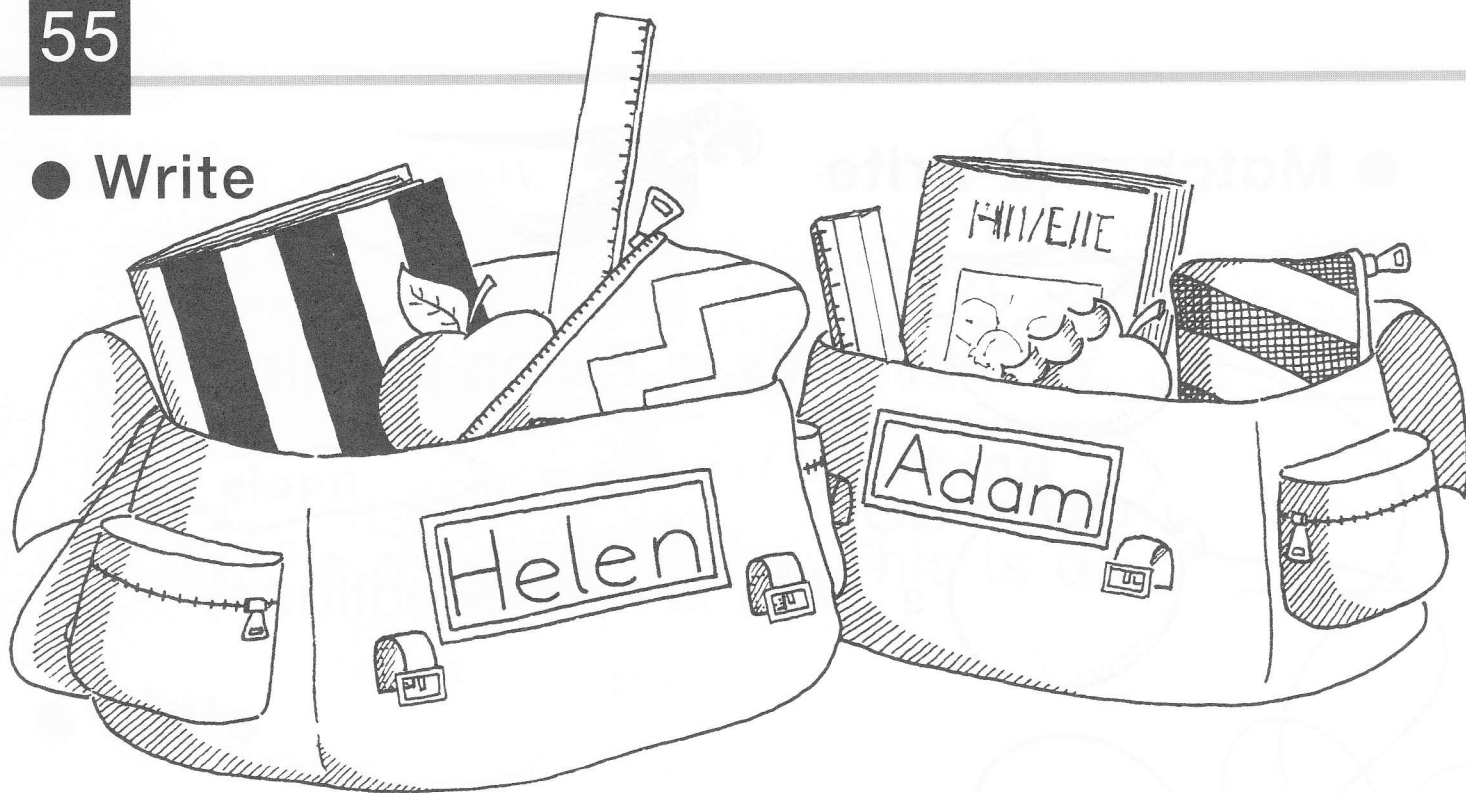

1 This is Helen's pencil case.

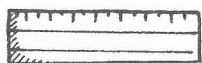

2 This is Adam's ruler.



3 This is \_\_\_\_\_'s book.



4 This is \_\_\_\_\_.

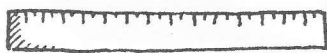

5 This is \_\_\_\_\_.

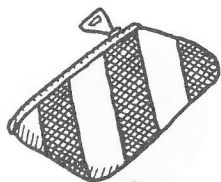

6 This is \_\_\_\_\_.



7 This is \_\_\_\_\_.



8 This is \_\_\_\_\_.

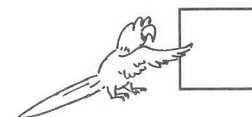

● Colour and write

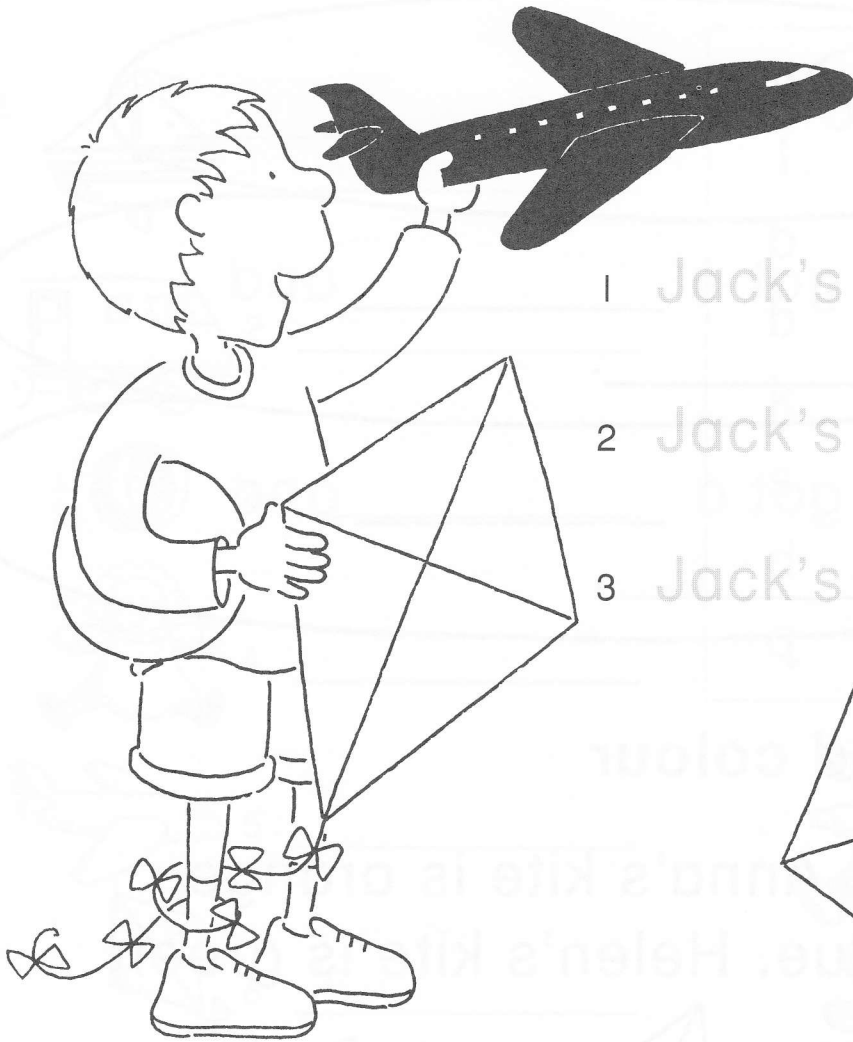

1 Jack's plane is black.

2 Jack's kite is \_\_\_\_\_.

3 Jack's ball is \_\_\_\_\_.

4 Jenny's kite is \_\_\_\_\_.

5 Jenny's ball is \_\_\_\_\_.

6 Jenny's boat is \_\_\_\_\_.

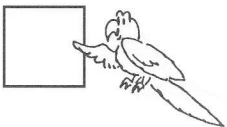
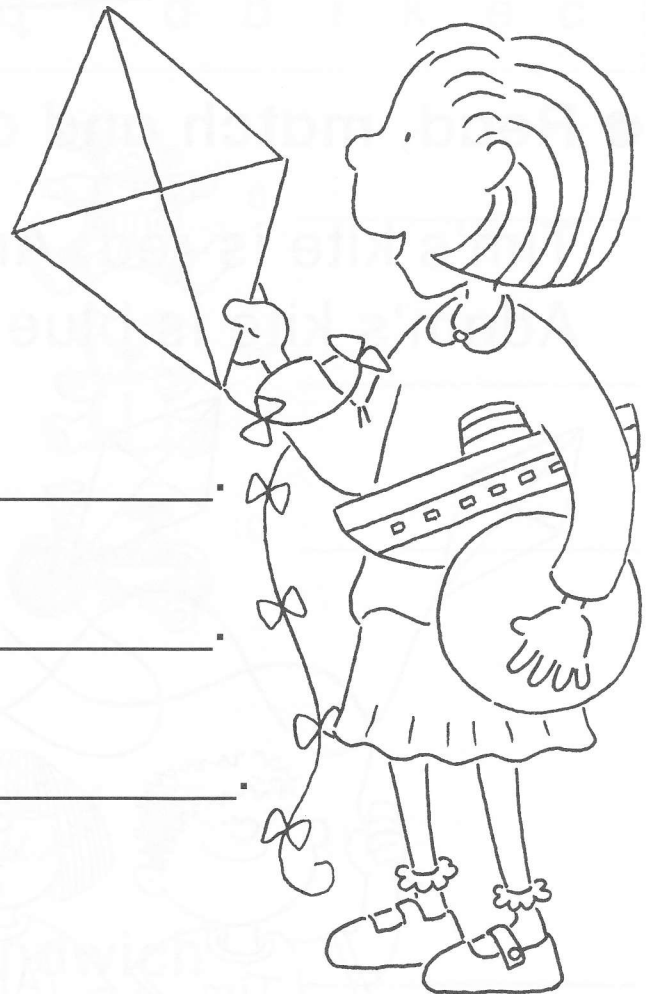

● Write



I've got a car and a \_\_\_\_\_.



I've got a \_\_\_\_\_ and  
a \_\_\_\_\_.



I've got a \_\_\_\_\_ and  
a \_\_\_\_\_.

● Read, match and colour

Tim's kite is red. Anna's kite is orange.  
Adam's kite is blue. Helen's kite is green.

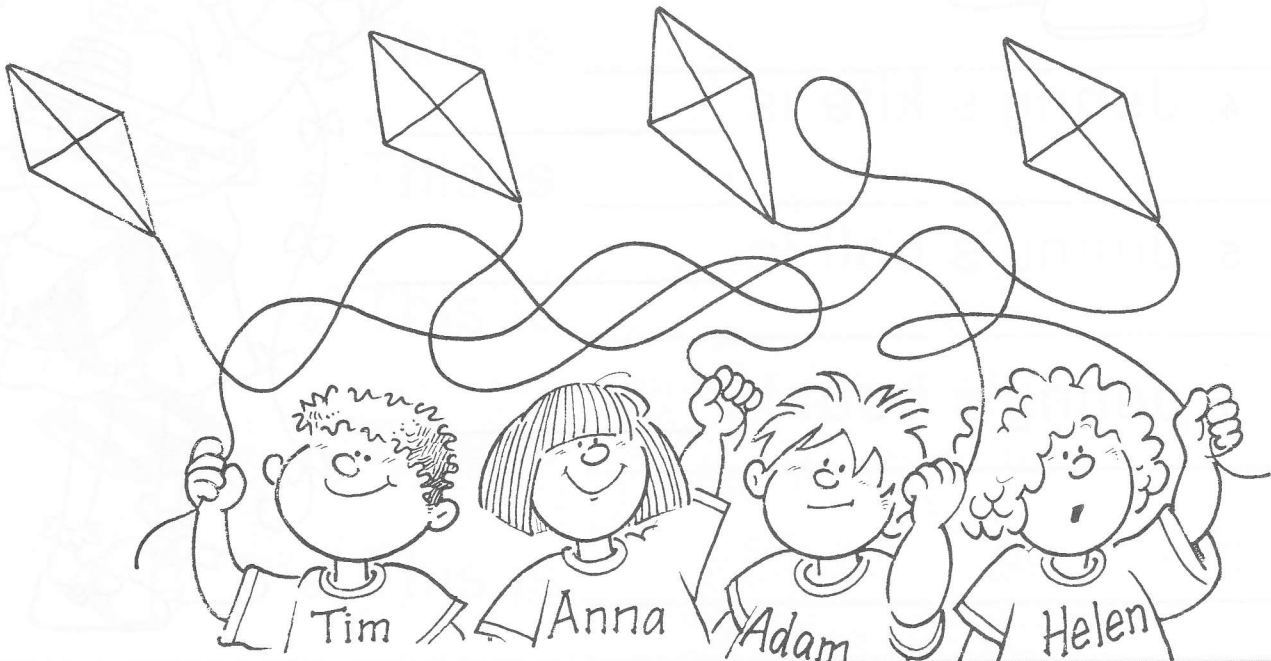

● Write

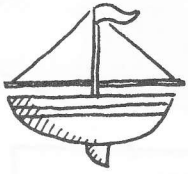

1 boat

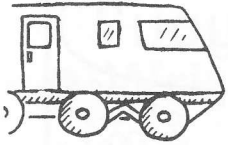

2 \_\_\_\_\_



3 \_\_\_\_\_



4 \_\_\_\_\_

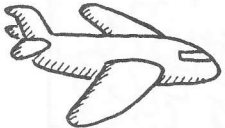

5 \_\_\_\_\_

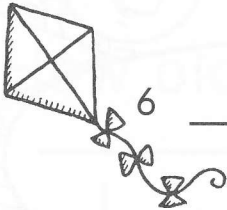

6 \_\_\_\_\_



7 \_\_\_\_\_

v	<u>b</u>	<u>o</u>	<u>a</u>	<u>t</u>	p	s	j
l	t	r	a	i	n	m	b
b	a	l	i	d	o	l	l
b	p	l	a	n	e	c	r
k	i	t	e	z	c	a	r
s	o	c	l	o	w	n	u
d	b	e	a	r	n	g	j
q	o	d	b	i	k	e	c



8 \_\_\_\_\_



9 \_\_\_\_\_

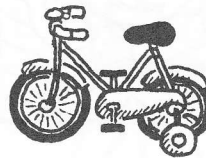

10 \_\_\_\_\_

● Odd one out



plane train car sandwich \_\_\_\_\_

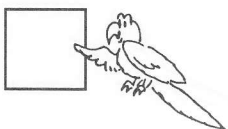

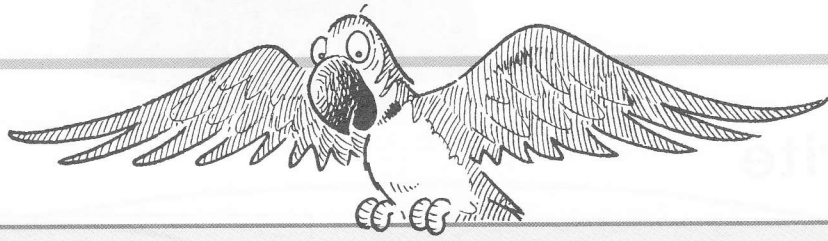

● Write

present    thank you    birthday    seven

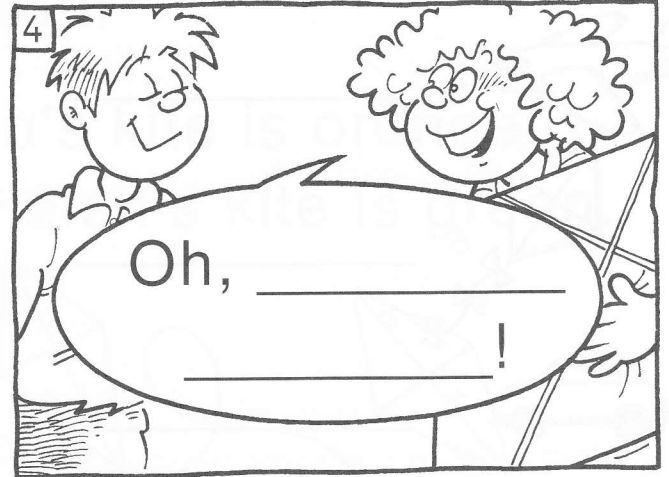
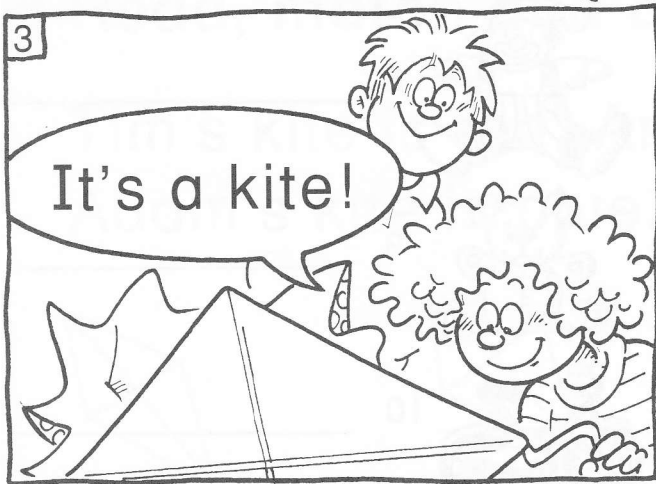
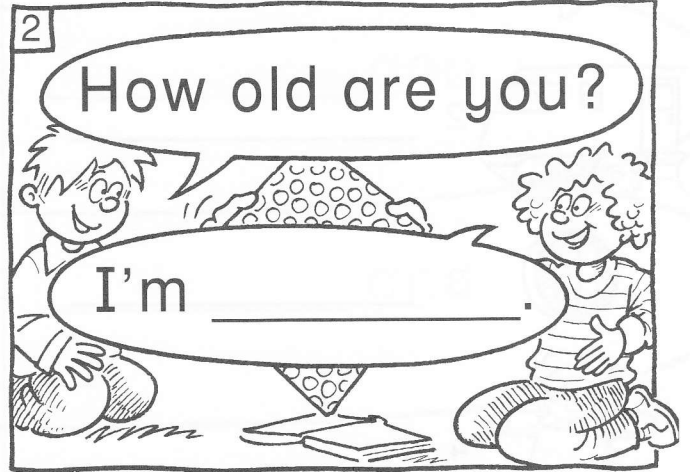

● Draw Helen's birthday cake



● Write

one \_\_\_\_\_ three \_\_\_\_\_

\_\_\_\_\_ nine \_\_\_\_\_

● Write

1 How old are you? I'm  $(2 + 2)$  four

2 How old are you? I'm  $(1 + 5)$  \_\_\_\_\_

3 How old are you? I'm  $(6 + 2)$  \_\_\_\_\_

4 How old are you? I'm  $(3 + 4)$  \_\_\_\_\_

5 How old are you? I'm  $(5 + 4)$  \_\_\_\_\_

6 How old are you? I'm  $(1 + 3)$  \_\_\_\_\_

● Odd one out

seven six monkey five \_\_\_\_\_

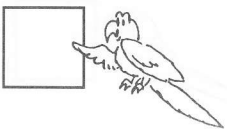



● Count and colour

She's four.



She's nine.



He's seven.



He's eight.







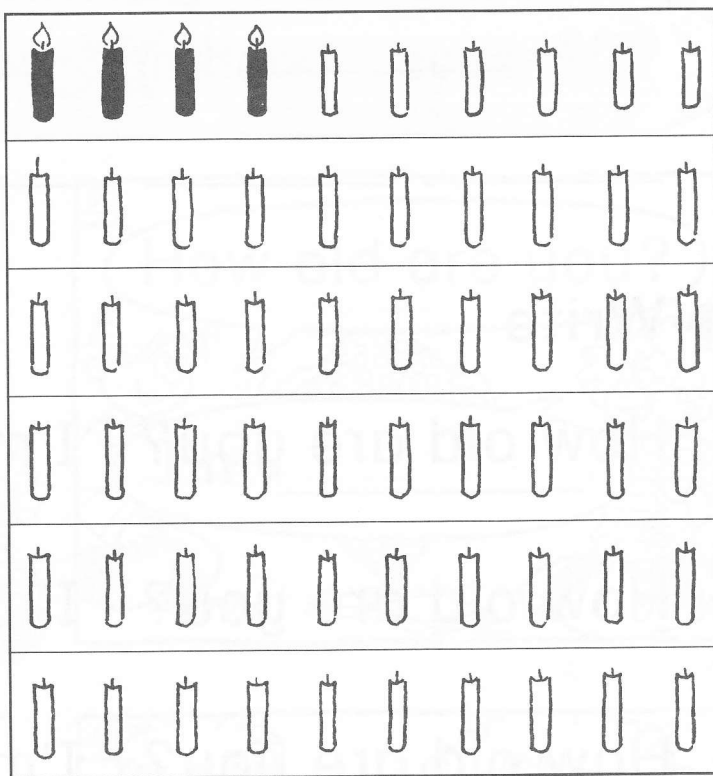

She's six.



He's two.



● Write

- 1 
- 2 
- 3 
- 4 
- 5 
- 6 

C				
C				
C				
C				
C				
C	a	t		

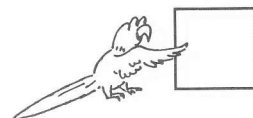

● Write

Adam Helen Jill Bill Tom  
Anna Jack Penny

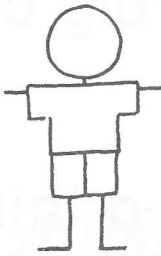

he

Adam

\_\_\_\_\_

\_\_\_\_\_

\_\_\_\_\_

\_\_\_\_\_

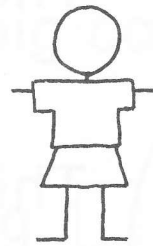

she

Helen

\_\_\_\_\_

\_\_\_\_\_

\_\_\_\_\_

\_\_\_\_\_

● Write



1 How old is she?

She's six.



2 How old is he?

He's \_\_\_\_\_.



3 How old is she?

\_\_\_\_\_.

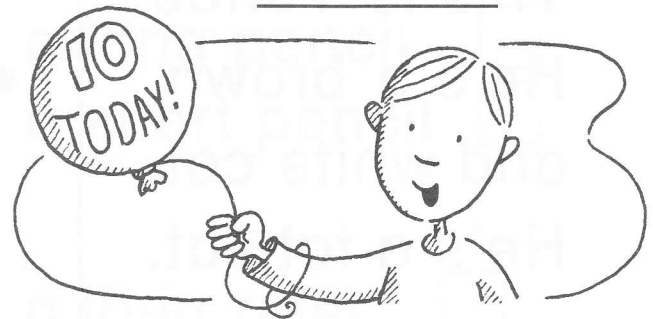

4 How old is he?

\_\_\_\_\_.

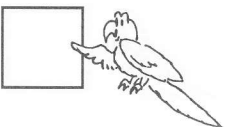

● Read and match



This is Fluffy. He's a big cat.

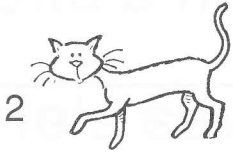

This is Snowy. She's a thin cat.



This is Tiny. She's a small cat.



This is Blackie. He's a fat cat.

● Read and draw

This is Toffee.  
He's a brown  
and white cat.  
He's a fat cat.



● Tick ✓

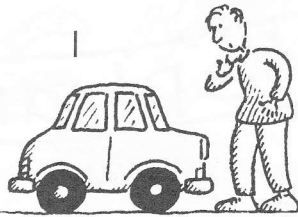

a small car

a big car



a small bag

a big bag

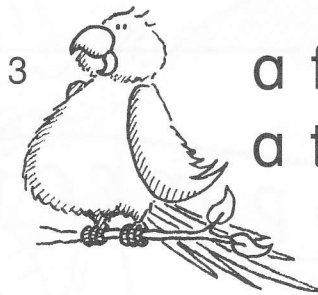

a fat parrot

a thin parrot



a fat clown

a thin clown

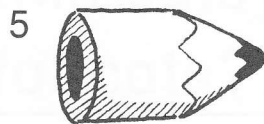

a long pencil

a short pencil

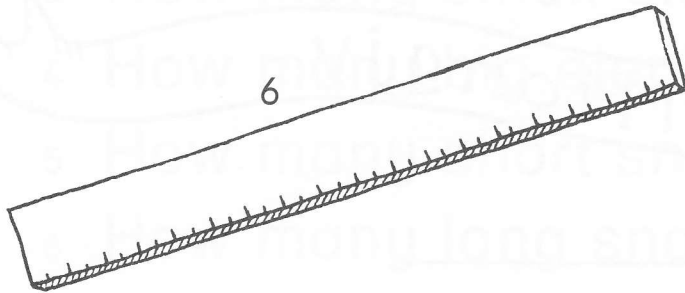

a long ruler

a short ruler

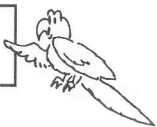

## ● Write

xw cat ke elephant a 

1 cat elephant

nmonkeys mouse 

2 \_\_\_\_\_

r bears p b parrot r f 

3 \_\_\_\_\_

v u kangaroo g bat f 

4 \_\_\_\_\_

k o a camel lion g j v 

5 \_\_\_\_\_

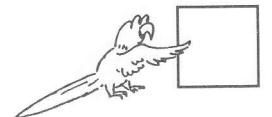

● Count and write

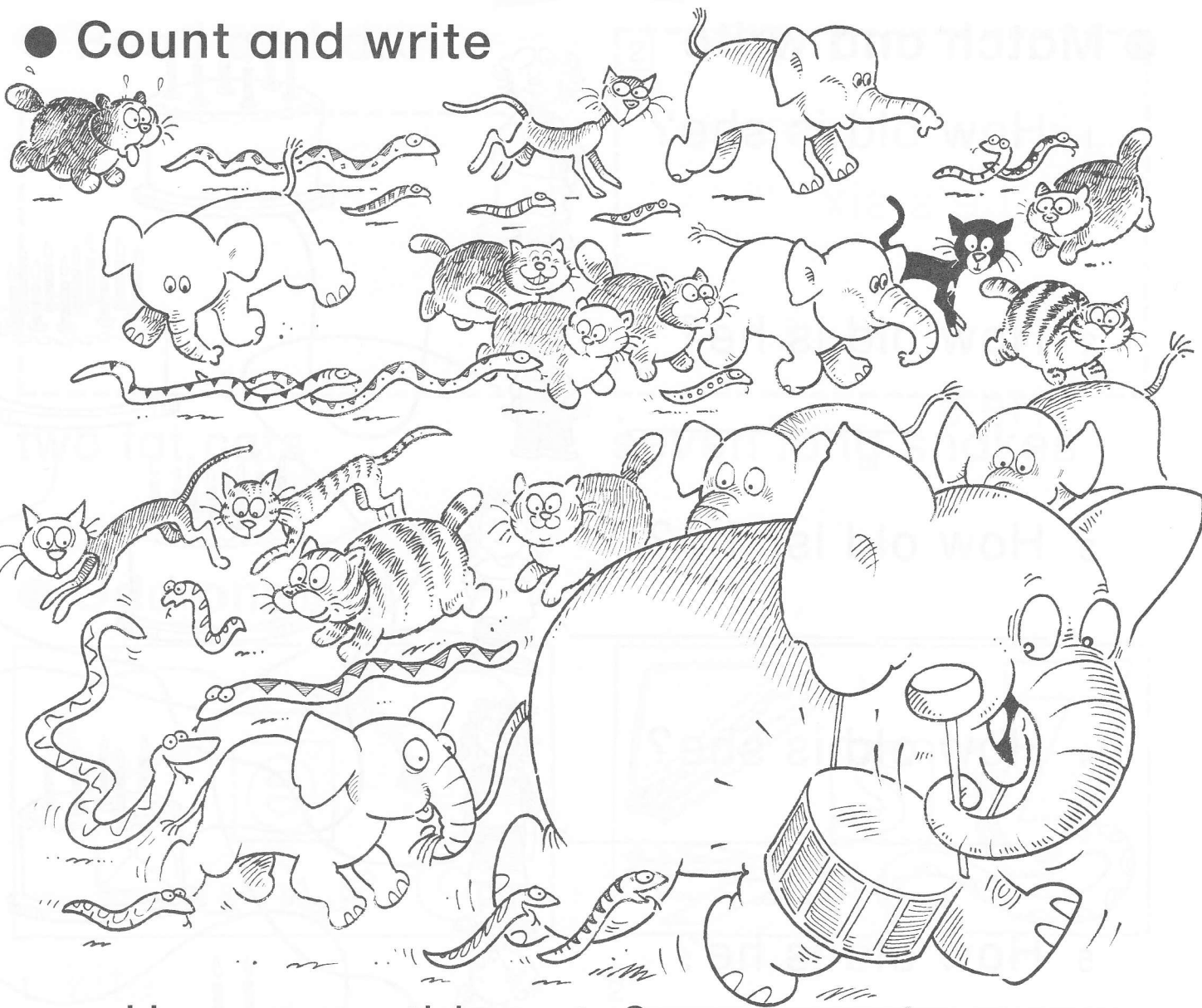

- 1 How many thin cats? four
- 2 How many fat cats? \_\_\_\_\_
- 3 How many small elephants? \_\_\_\_\_
- 4 How many big elephants? \_\_\_\_\_
- 5 How many short snakes? \_\_\_\_\_
- 6 How many long snakes? \_\_\_\_\_

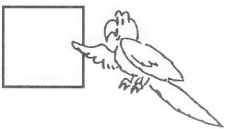



● Match and write

1 How old is she?

She's six.



2 How old is he?

He's \_\_\_\_\_.



3 How old is she?

\_\_\_\_\_.



4 How old is she?

\_\_\_\_\_.



5 How old is he?

\_\_\_\_\_.



● Write about you

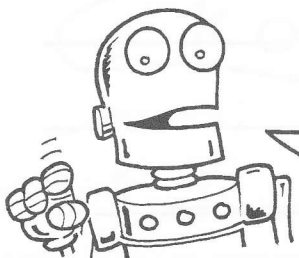

How old are you?

I'm \_\_\_\_\_.



● Read and draw



two fat cats



seven long snakes

● Odd one out

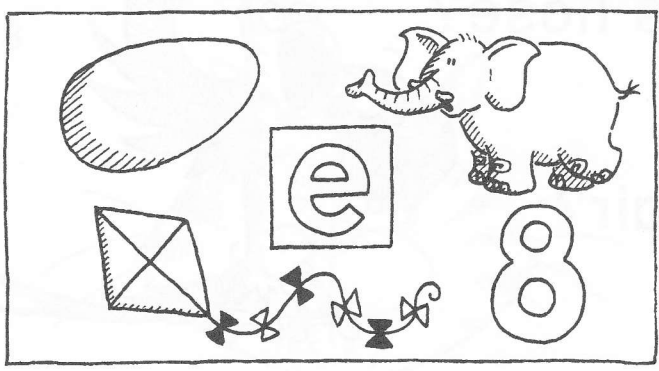

1 kite

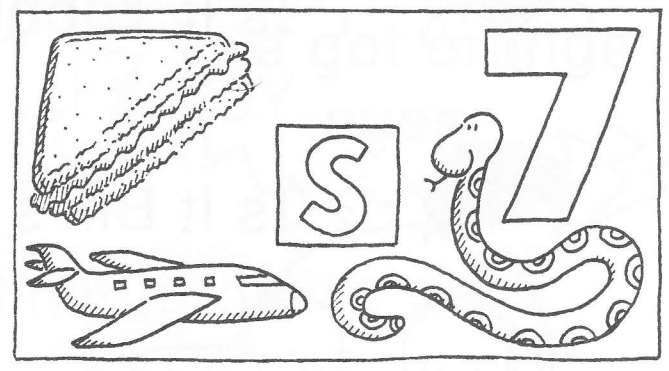

2 \_\_\_\_\_

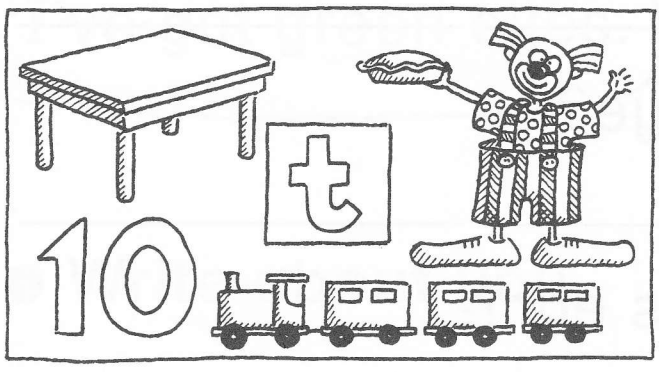

3 \_\_\_\_\_

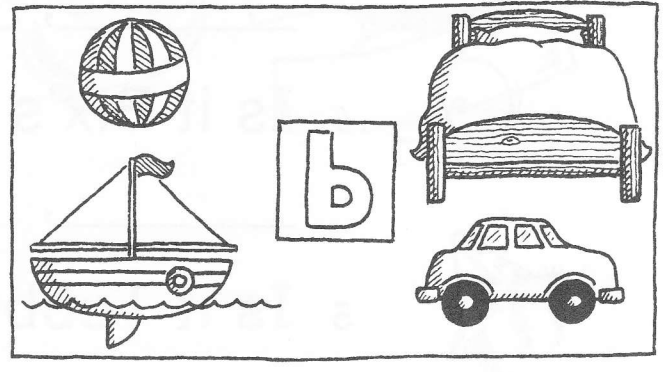

4 \_\_\_\_\_

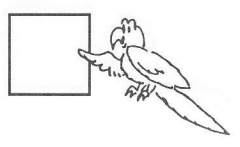

● Match and write

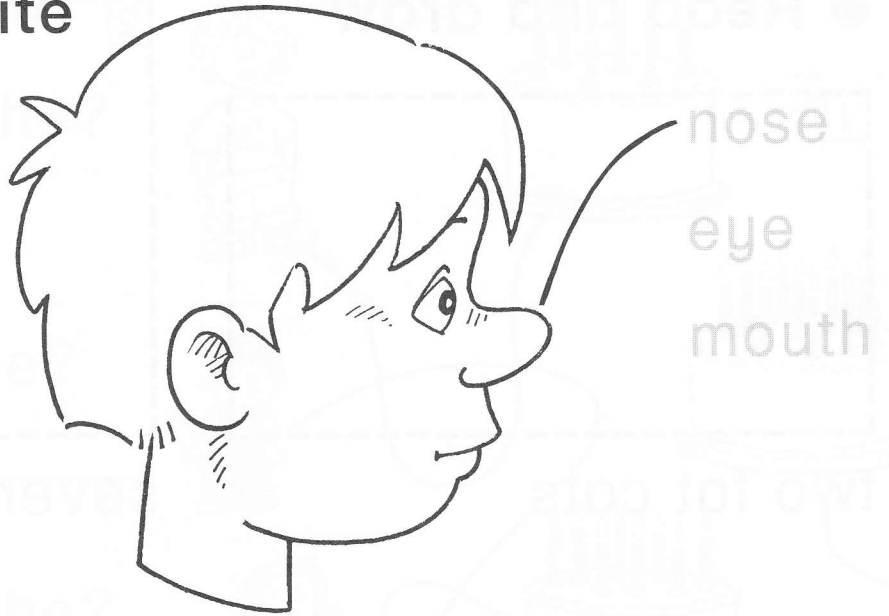

● Write



1 Is it Tabby's nose?

Yes, it is.



2 Is it Bix's hair?

No, it isn't.



3 Is it Bix's nose?

\_\_\_\_\_, \_\_\_\_\_.



4 Is it Bix's eye?

\_\_\_\_\_, \_\_\_\_\_.



5 Is it Tabby's ear?

\_\_\_\_\_, \_\_\_\_\_.

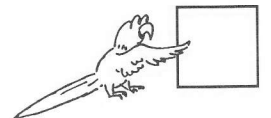

● Read and colour

1



I've got green eyes  
and brown hair.

2

I've got blue eyes  
and fair hair.



3



I've got green eyes.

4

I've got orange  
eyes.

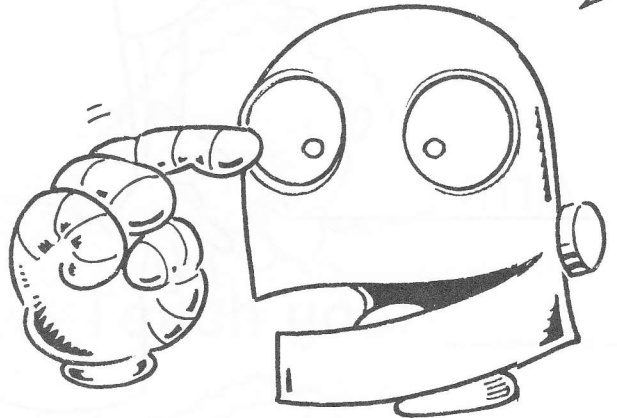

● Write about you

I've got \_\_\_\_\_ eyes and \_\_\_\_\_ hair.

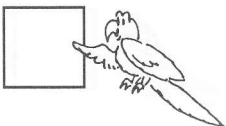

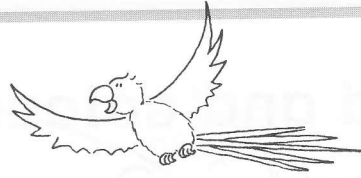

● Write

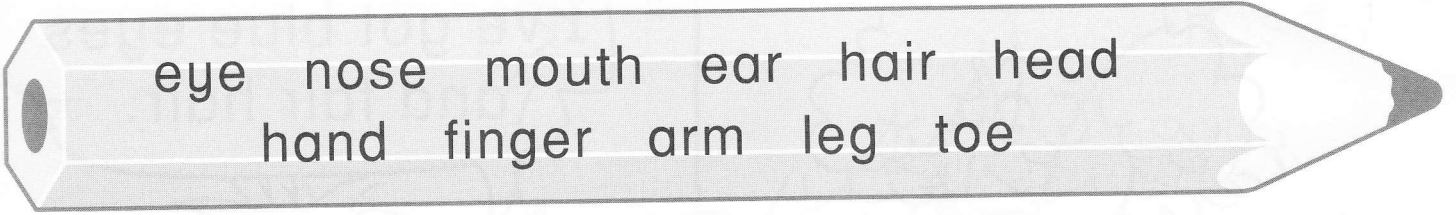

1 head \_\_\_\_\_

2 \_\_\_\_\_

3 \_\_\_\_\_

4 \_\_\_\_\_

5 \_\_\_\_\_

6 \_\_\_\_\_

7 arm \_\_\_\_\_

8 \_\_\_\_\_

9 \_\_\_\_\_

10 \_\_\_\_\_

11 \_\_\_\_\_

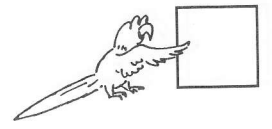

● Write

nose ear head toes  
mouth eye leg arm



1 Touch your head.



2 Touch your \_\_\_\_\_.



3 Touch your \_\_\_\_\_.



4 Touch your \_\_\_\_\_.



5 Touch your \_\_\_\_\_.



6 Touch your \_\_\_\_\_.



7 Touch your \_\_\_\_\_.



8 Touch your \_\_\_\_\_.

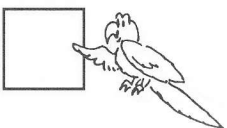



● Read and colour

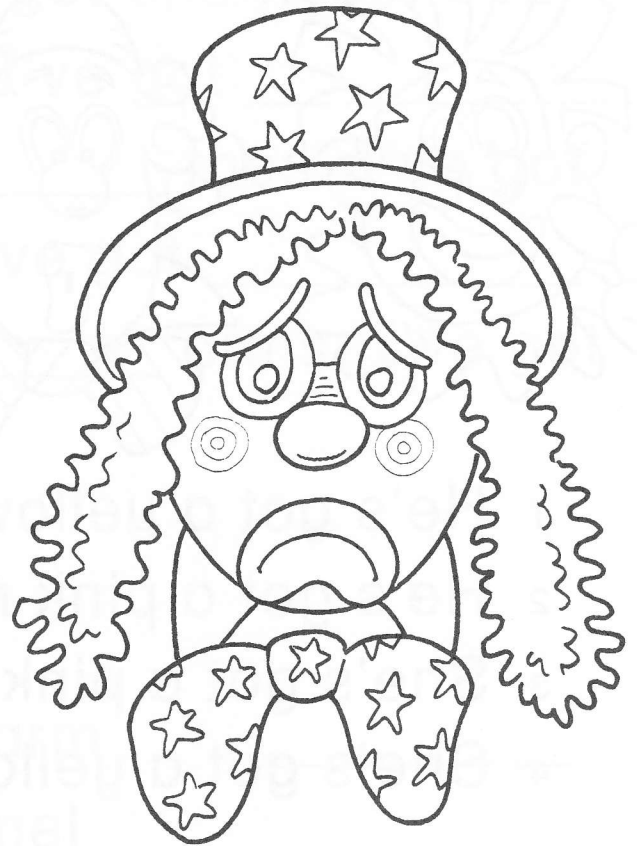

- 1 Bimbo is a clown. He's got a red nose. He's got a blue mouth. He's got yellow hair and green eyes.
- 2 Holly is a clown. She's got a white nose. She's got a red mouth. She's got orange hair and blue eyes.

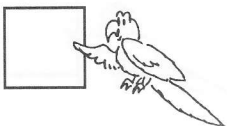

● Write



1 He's got a yellow nose.

2 He's got a pink nose.

3 She's got a pink nose.

4 She's got a yellow nose.

Happy.

\_\_\_\_\_.

\_\_\_\_\_.

\_\_\_\_\_.

● Write about Tabby

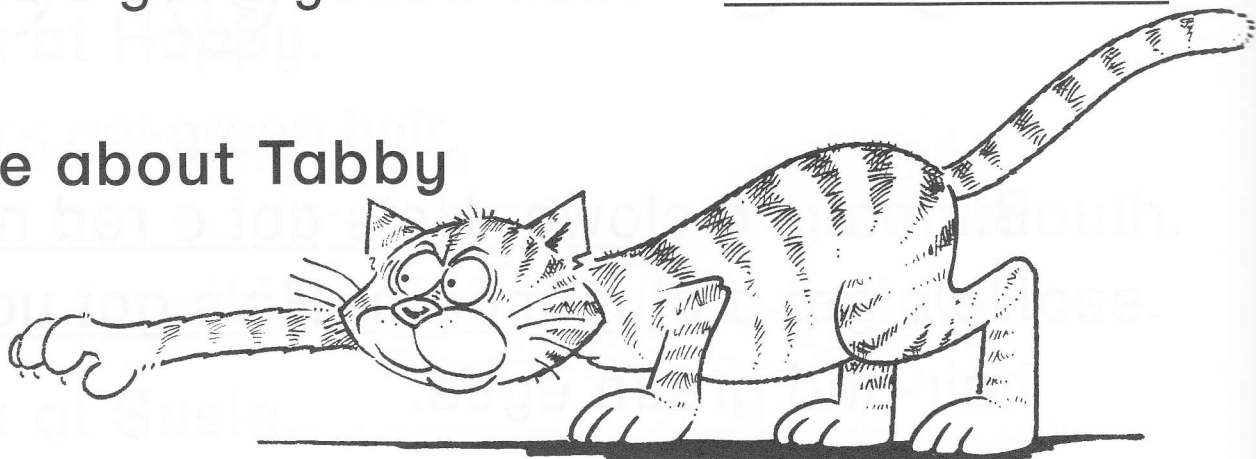

She's got two ears. She's got \_\_\_\_\_

legs. She's \_\_\_\_\_ nose.

\_\_\_\_\_ eyes.



● Write about you

I've got two eyes. I've got one nose. I've got \_\_\_\_\_ ears. I've got \_\_\_\_\_ mouth. I've got \_\_\_\_\_ toes. I've got \_\_\_\_\_ fingers. I've got \_\_\_\_\_ hands. I've got \_\_\_\_\_ arms. I've got \_\_\_\_\_ head.

● Odd one out

toe finger banana arm  
hand eye nose camel  
mouth train leg ear

\_\_\_\_\_

\_\_\_\_\_

\_\_\_\_\_

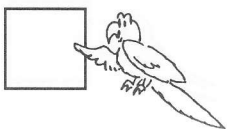

● Read and colour

1 I've got brown eyes and black hair.



2 I've got fair hair and blue eyes.



3 I've got brown hair and green eyes.



● Odd one out

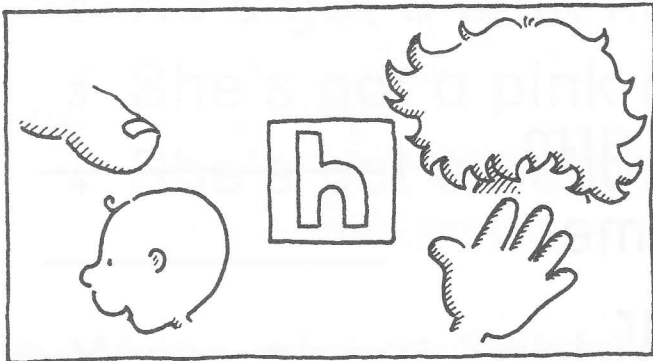

1 toe

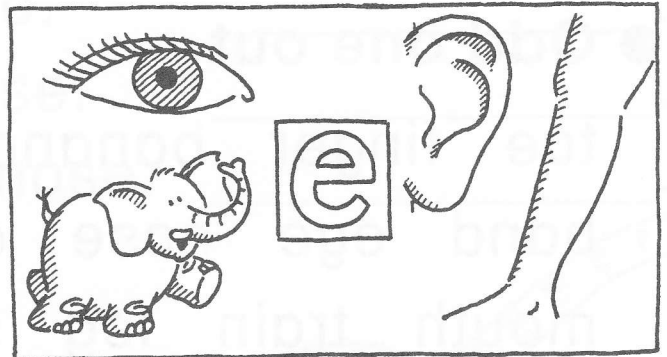

2 \_\_\_\_\_

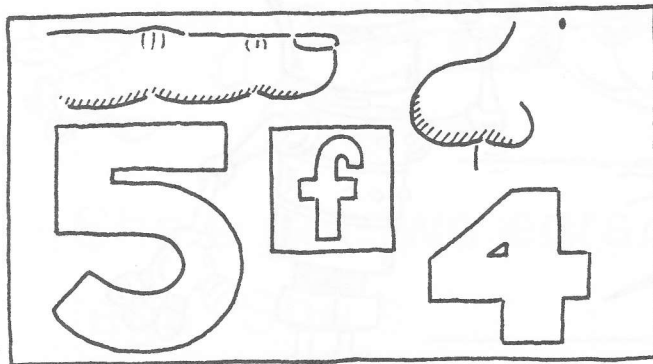

3 \_\_\_\_\_

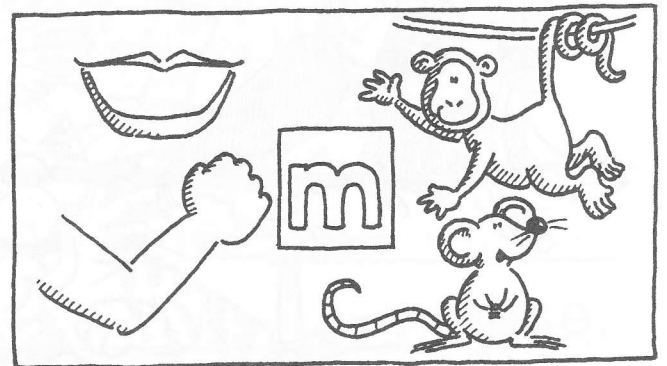

4 \_\_\_\_\_



● Write

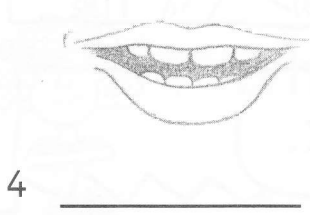
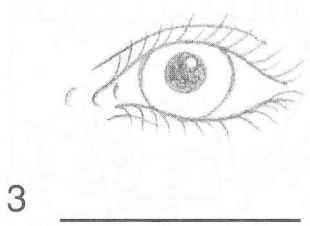
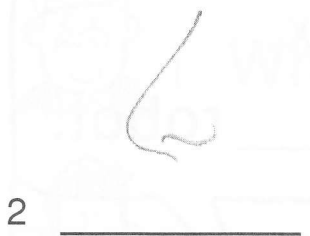

r	j	n	t	o	e	s	t
n	o	s	e	v	e	y	e
q	s	m	o	u	t	h	r
o	e	u	h	e	a	d	g
f	i	n	g	e	r	l	t
p	h	a	n	d	t	o	q
e	a	r	p	a	r	m	l
o	h	t	l	e	g	p	s

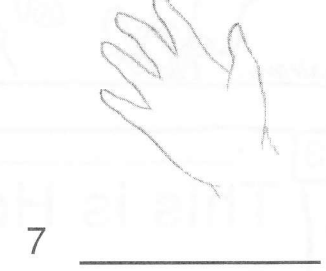
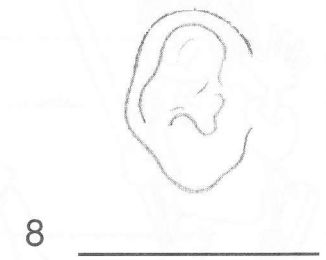
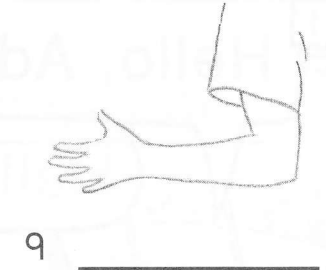
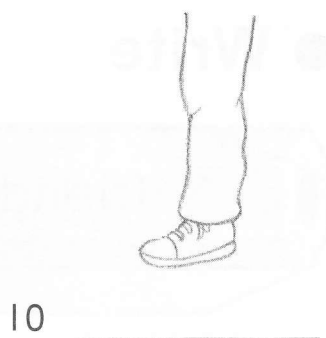
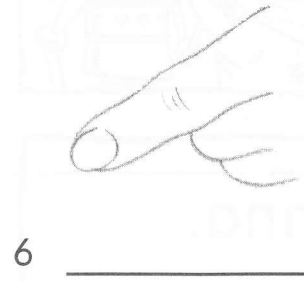
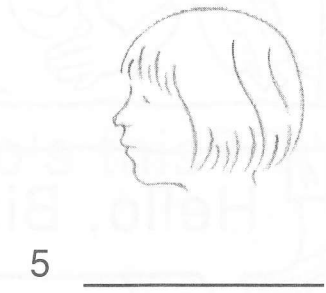

● Read and colour

This is Sue and John.  
 She's got blue eyes and fair hair.  
 He's got green eyes and brown hair.

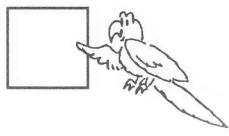

● Write

mother brother grandfather friend  
sister father grandmother



1 Who's this? It's Adam's grandfather.



2 Who's this? It's Adam's \_\_\_\_\_.



3 Who's this? It's Adam's \_\_\_\_\_.



4 Who's this? It's \_\_\_\_\_.



5 Who's this? \_\_\_\_\_.



6 Who's this? \_\_\_\_\_.



7 Who's this? \_\_\_\_\_.

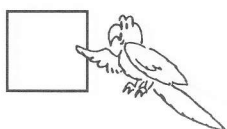



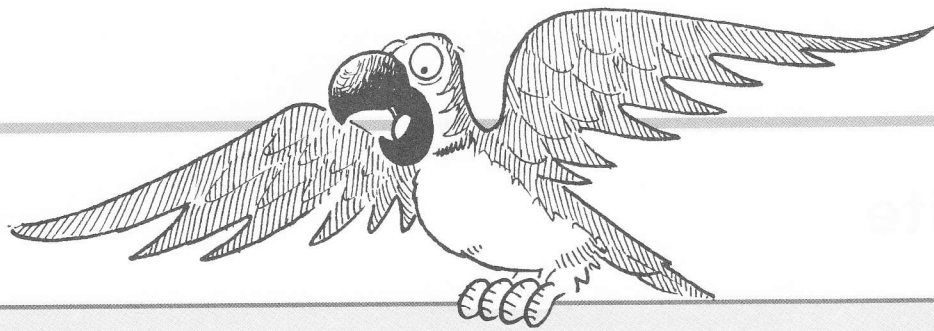

● Write

father hand leg mother eye sister  
brother arm nose grandmother



● Odd one out

grandfather ruler father sister \_\_\_\_\_



● Draw, colour and write about your friend

This is my friend. My friend's got \_\_\_\_\_  
 hair and \_\_\_\_\_ eyes.

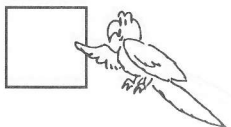

● Count and write

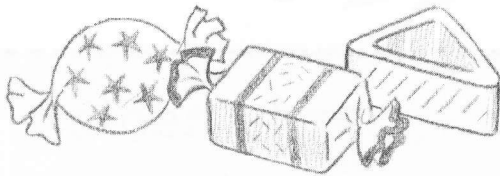

1 There are three sweets.

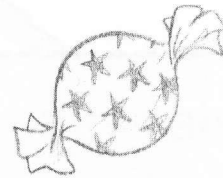

2 There's one sweet.

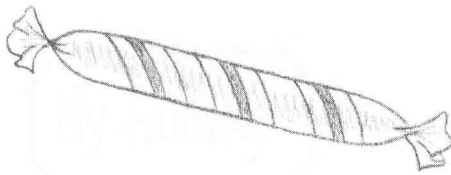

3 There's \_\_\_\_\_ sweet.

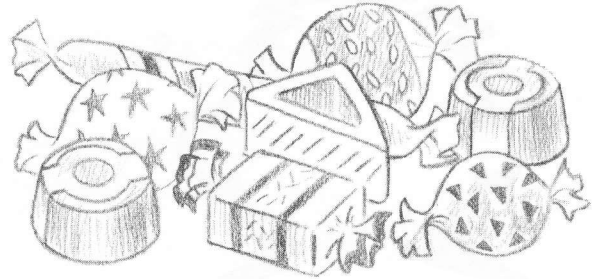

4 There are \_\_\_\_\_ sweets.

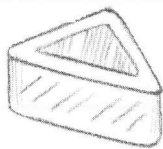

5 \_\_\_\_\_ sweet.

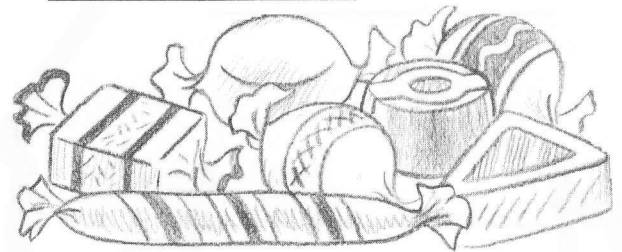

6 \_\_\_\_\_ sweets.

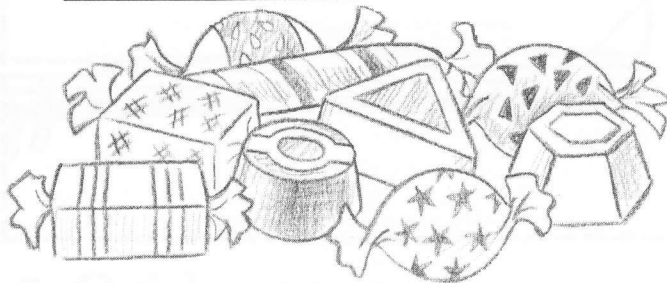

7 \_\_\_\_\_



8 \_\_\_\_\_



● Match and write

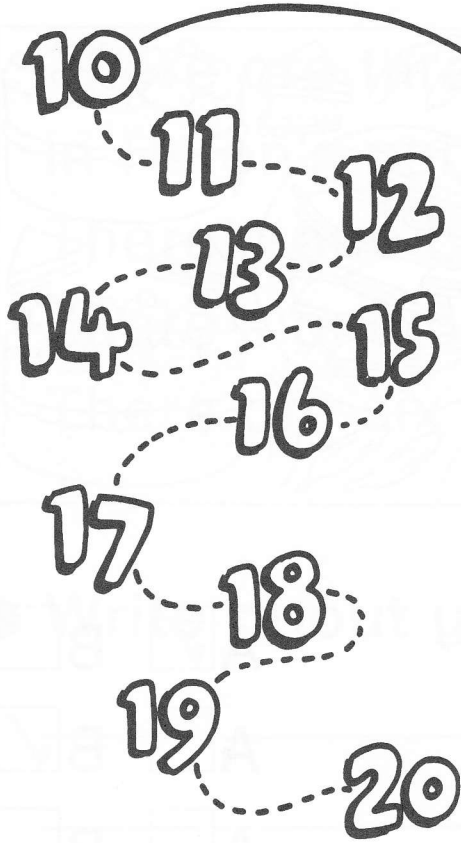

twelve  
 fourteen  
 sixteen  
 nineteen  
 seventeen  
 ten  
 eighteen  
 twenty  
 thirteen  
 fifteen  
 eleven

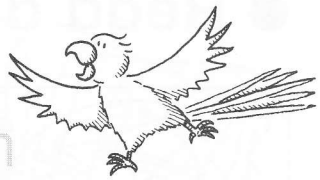

● Count and colour

fourteen



eleven



seventeen



twenty



fifteen



twelve

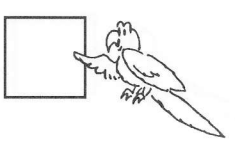

## ● Read and tick

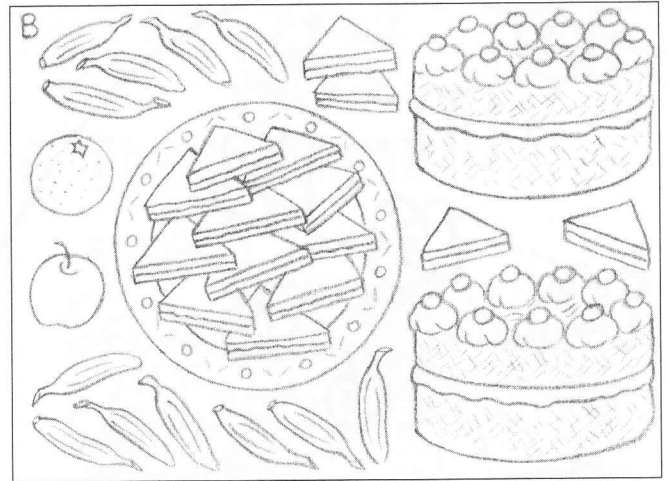
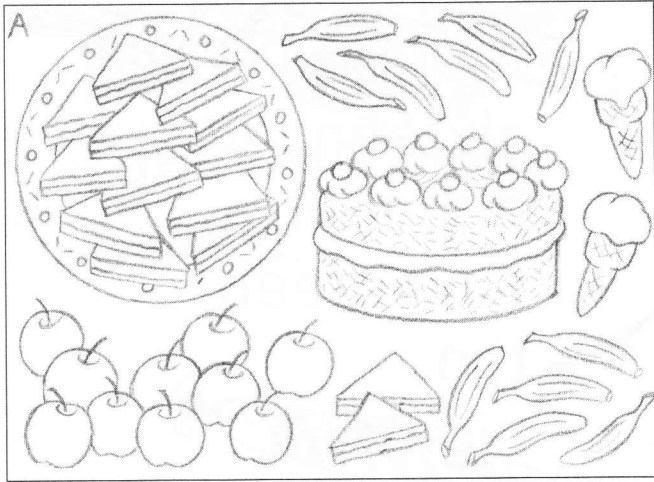

- |    |                                |                                       |                                       |
|----|--------------------------------|---------------------------------------|---------------------------------------|
| 1  | There's one cake.              | A <input checked="" type="checkbox"/> | B <input type="checkbox"/>            |
| 2  | There are two cakes.           | A <input type="checkbox"/>            | B <input checked="" type="checkbox"/> |
| 3  | There are ten apples.          | A <input type="checkbox"/>            | B <input type="checkbox"/>            |
| 4  | There are fourteen sandwiches. | A <input type="checkbox"/>            | B <input type="checkbox"/>            |
| 5  | There are twelve bananas.      | A <input type="checkbox"/>            | B <input type="checkbox"/>            |
| 6  | There's one orange.            | A <input type="checkbox"/>            | B <input type="checkbox"/>            |
| 7  | There's one apple.             | A <input type="checkbox"/>            | B <input type="checkbox"/>            |
| 8  | There are two ice creams.      | A <input type="checkbox"/>            | B <input type="checkbox"/>            |
| 9  | There are eleven bananas.      | A <input type="checkbox"/>            | B <input type="checkbox"/>            |
| 10 | There are fifteen sandwiches.  | A <input type="checkbox"/>            | B <input type="checkbox"/>            |



● Read and colour

There are three red pencils in Helen's pencil case.

There's one blue pencil.

There's one orange pencil.

There are six yellow pencils.



● Write about your pencil case

---



---

● Write

1 17



3 16



6 7

S								
S								
S								
S								
S								
S	e	v	e	n				

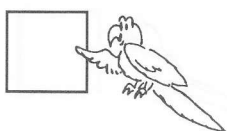
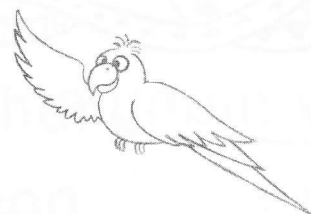



● Write

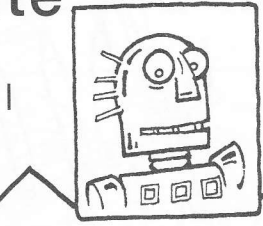

Who's this? It's my father.

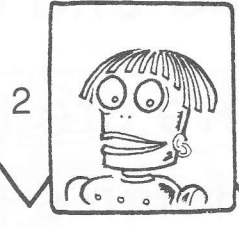

Who's this? It's my \_\_\_\_\_.



Who's this? It's my \_\_\_\_\_.

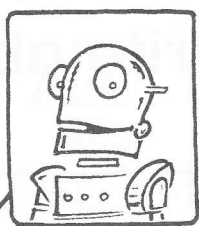
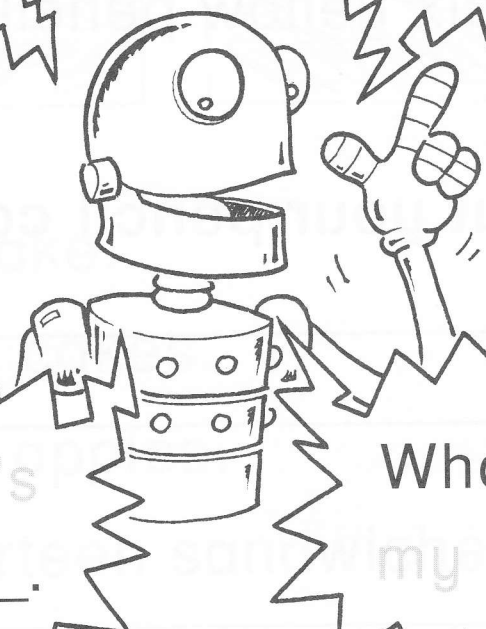

Who's this? It's my \_\_\_\_\_.

● Count and write

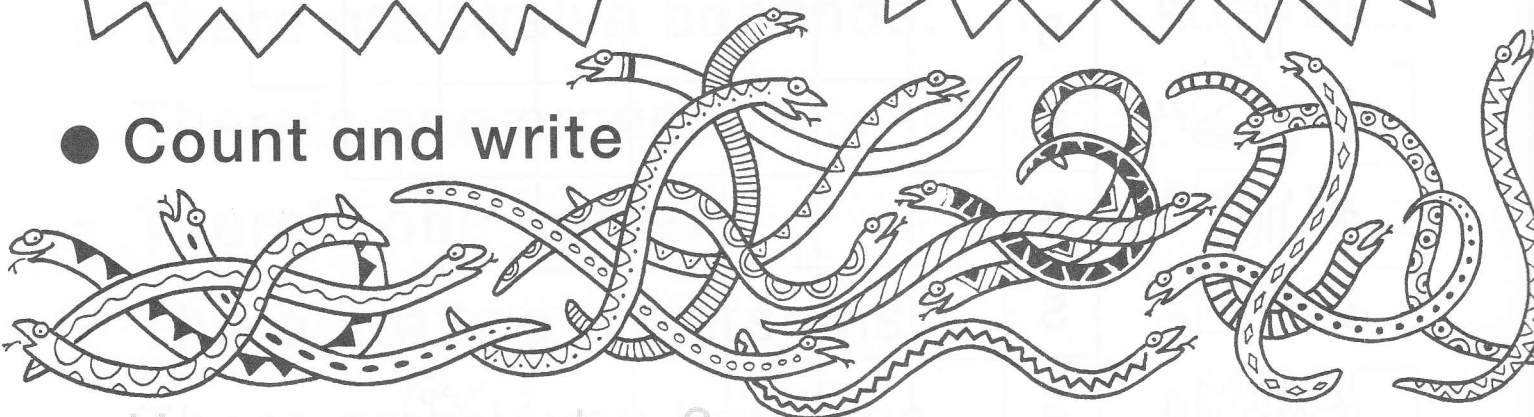

How many snakes?

There are \_\_\_\_\_ snakes.



● Read and colour

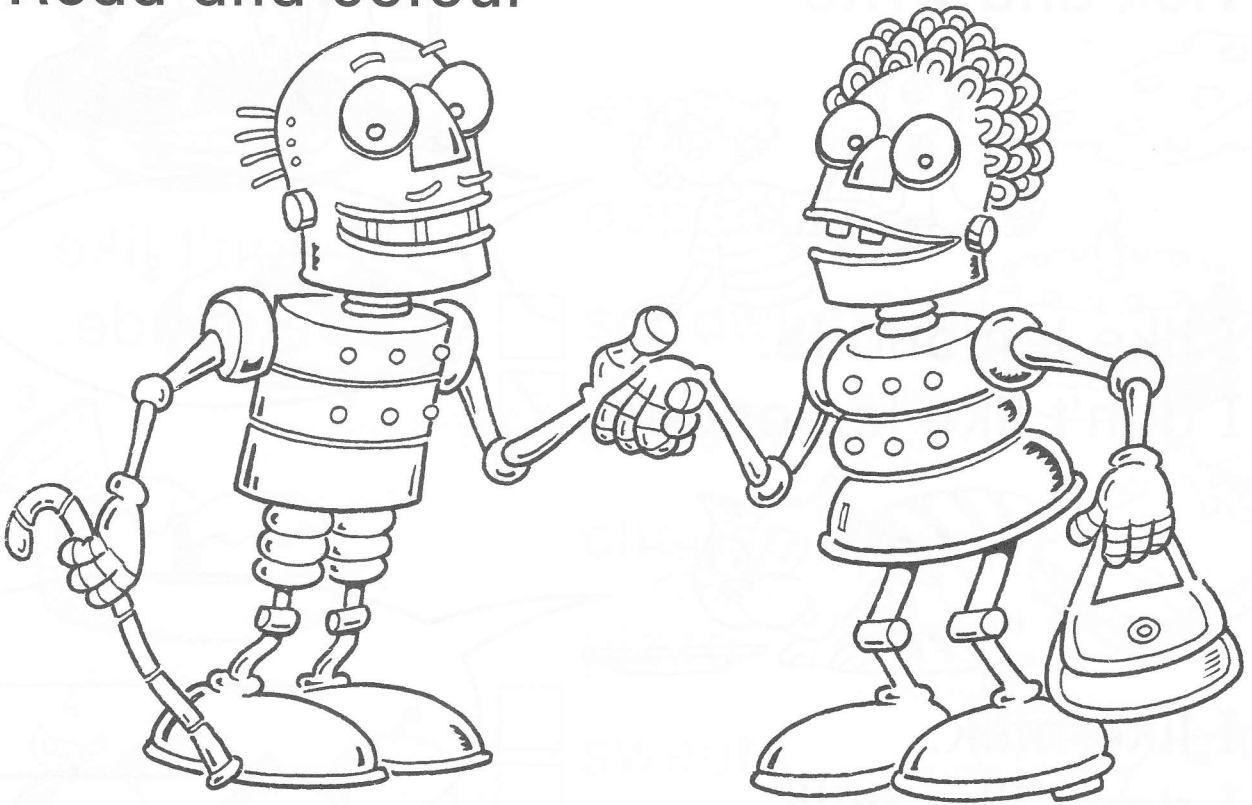

This is Bix's grandfather and grandmother. He's got red legs and she's got green legs. He's got green hair and she's got blue hair. He's got a blue mouth and a blue nose. She's got a red mouth and a red nose.

● Odd one out

father sister finger brother \_\_\_\_\_  
 sixteen fifteen twenty egg \_\_\_\_\_

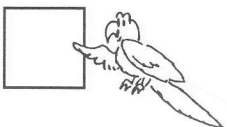

● Write and colour

friend

Hanna

He's my

Hello

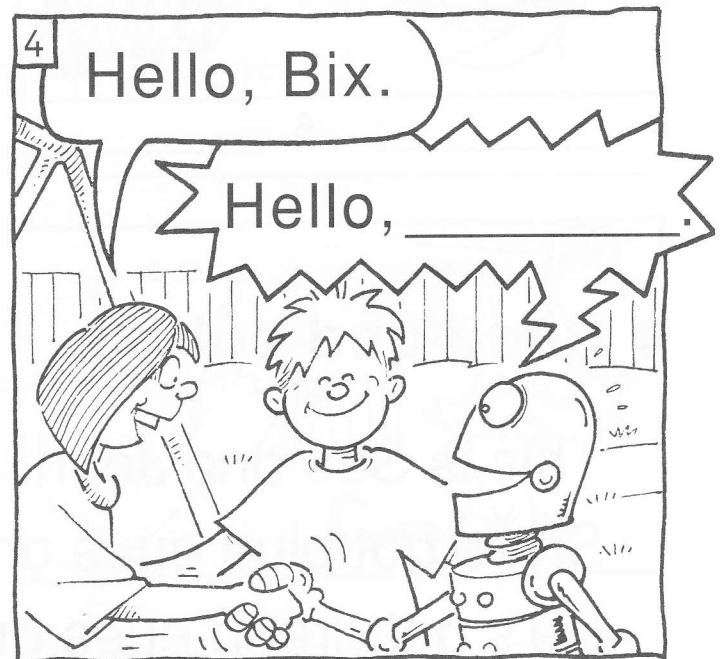
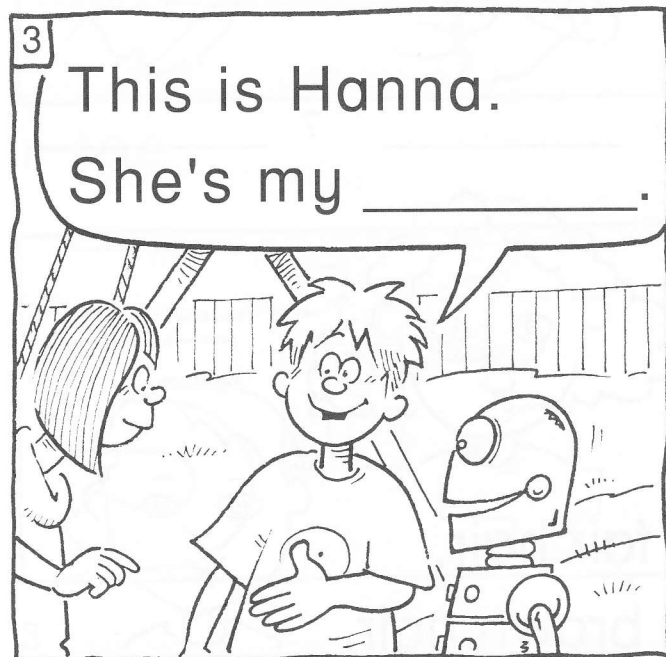
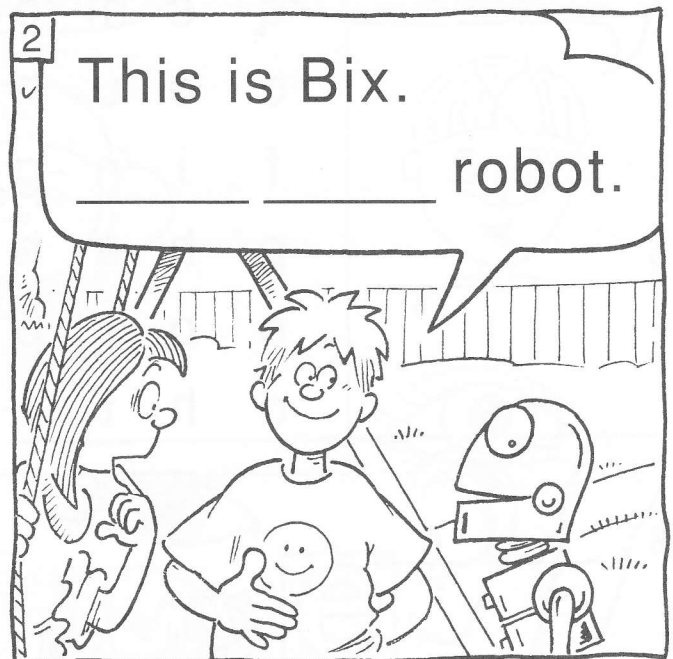
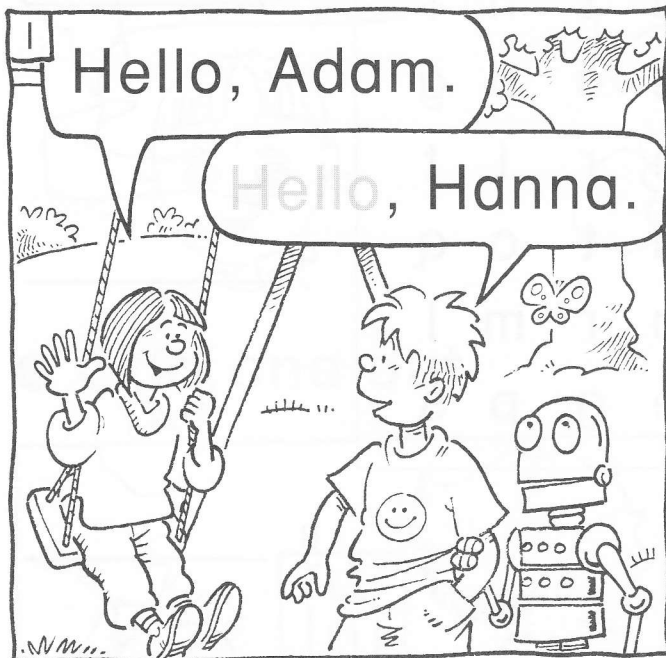

● Match



green hair

red hair

a purple mouth

a green mouth

a yellow nose

a pink nose

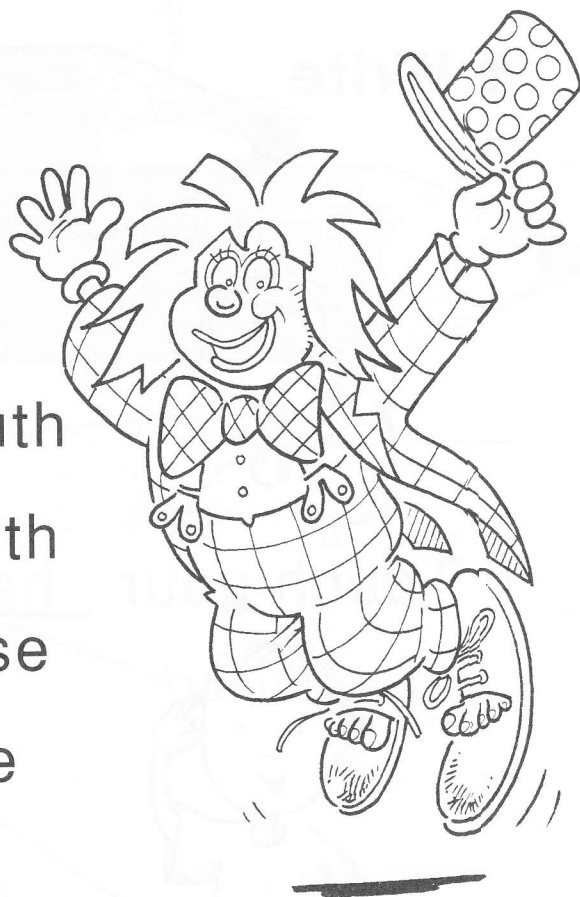

● Write

Look at Happy.

1 He's got green hair.

2 \_\_\_\_\_ a green mouth.

3 \_\_\_\_\_ a yellow nose.

Look at Susie.

4 She's got red hair.

5 \_\_\_\_\_ a purple mouth.

6 \_\_\_\_\_ a pink nose.



● Tick and write



- 1 I like lemonade.
- I don't like lemonade.

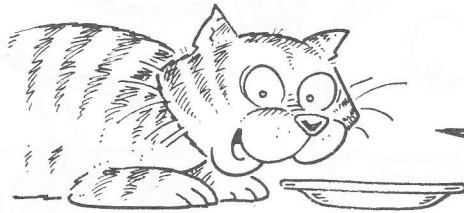

- 2 I like milk.
- I don't like milk.

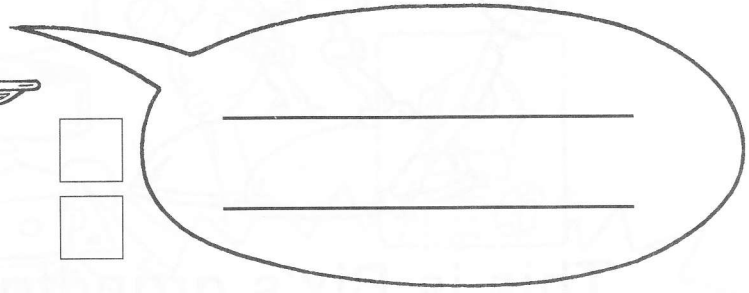

- 3 I like milk.
- I don't like milk.

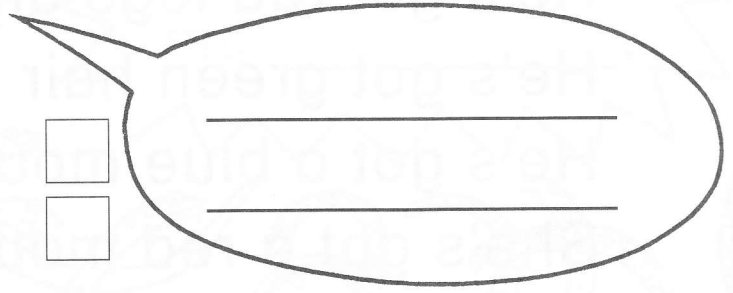

- 4 I like cake.
- I don't like cake.

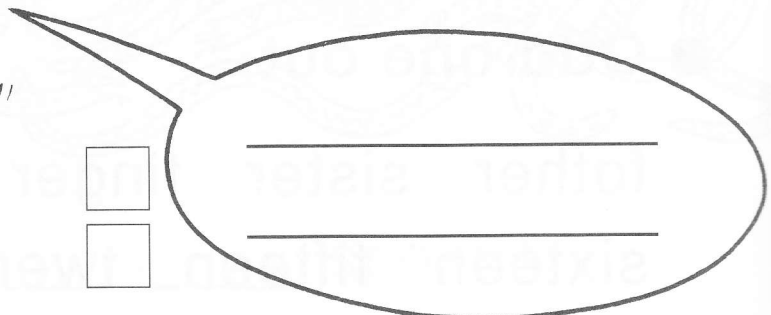

● Match and write

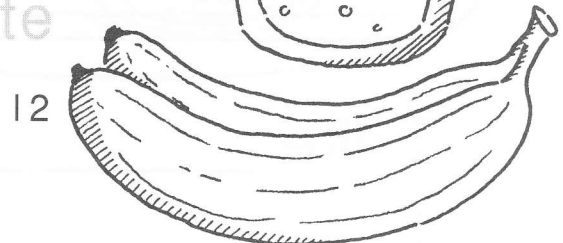
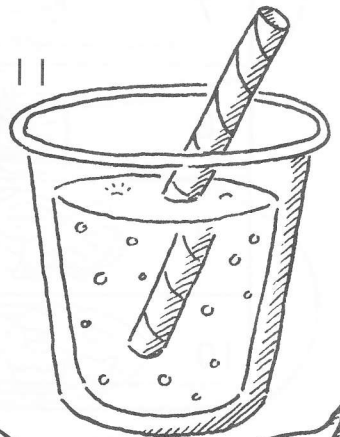
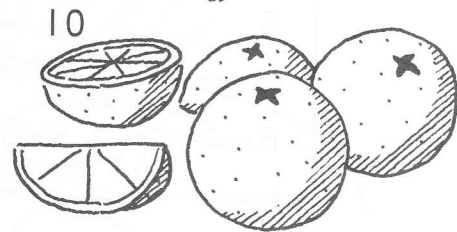
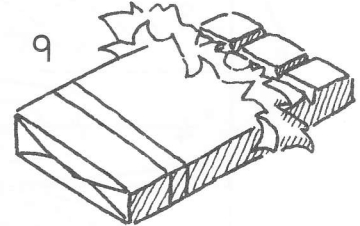
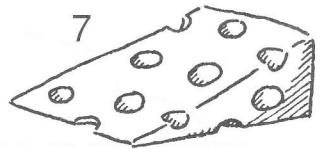
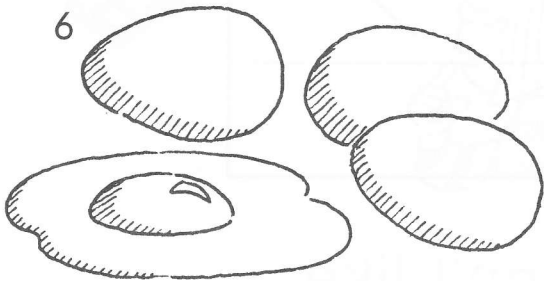
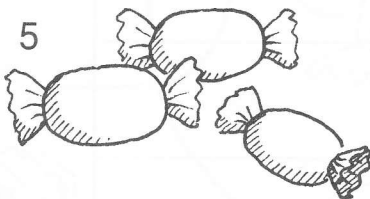
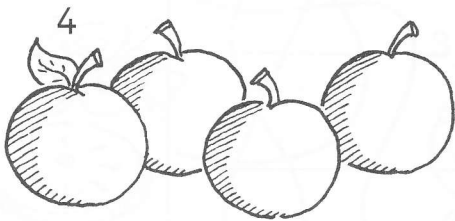
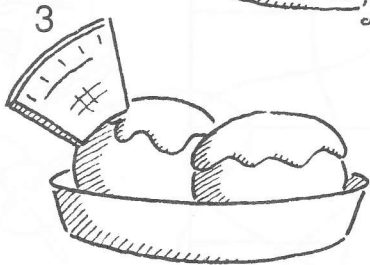
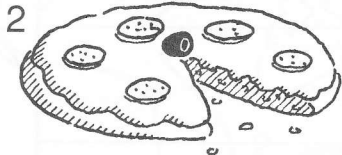
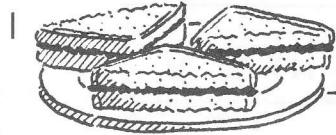

eggs  
apples  
sandwiches  
bananas  
cheese  
pizza  
sweets  
cake  
oranges  
ice cream  
lemonade  
chocolate





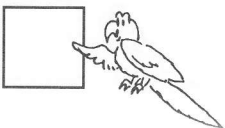

● Odd one out

cheese pizza parrot chocolate \_\_\_\_\_



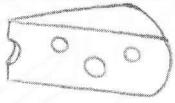

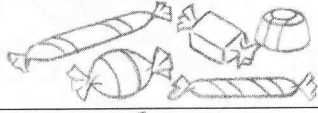
● Tick and write about you

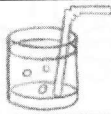
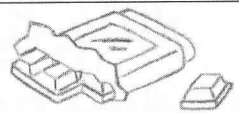
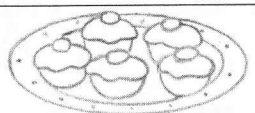
		I like ✓	I don't like ✓
1			
2			
3			
4			
5			
6			
7			
8			
9			
10			



I like \_\_\_\_\_.

I don't like \_\_\_\_\_.

I \_\_\_\_\_.

I \_\_\_\_\_.

I \_\_\_\_\_.

I \_\_\_\_\_.

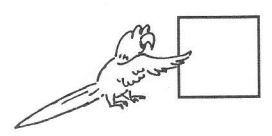

● Match and write

1 I like pizza.  
I don't like eggs.

2 I like \_\_\_\_\_.  
I don't like \_\_\_\_\_.

3 \_\_\_\_\_  
\_\_\_\_\_

4 \_\_\_\_\_  
\_\_\_\_\_

● Odd one out

egg bin banana sandwich \_\_\_\_\_

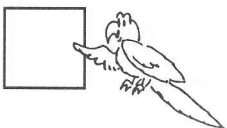

● Colour the c words yellow. Colour the p words red



● Odd one out

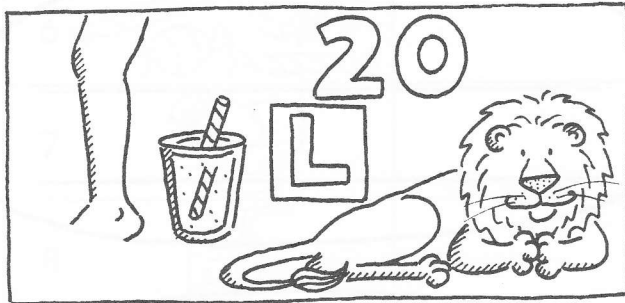

1 twenty

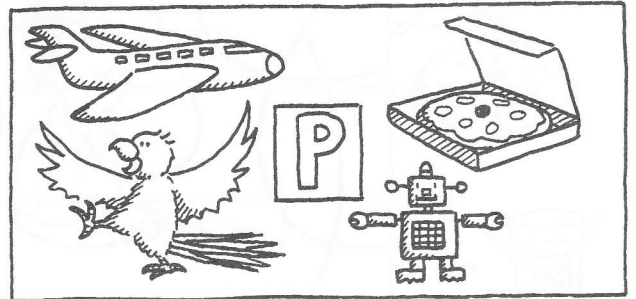

2 \_\_\_\_\_

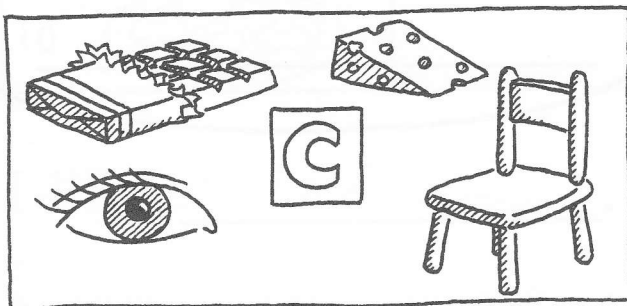

3 \_\_\_\_\_

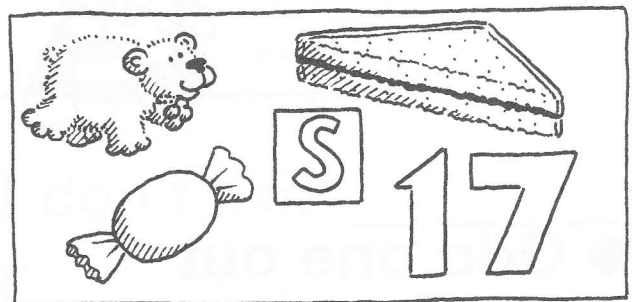

4 \_\_\_\_\_



● Write

1 20

2 12



6 10

t	w	e	n	t	y
t					
t					
t					
t					
t					



● Draw

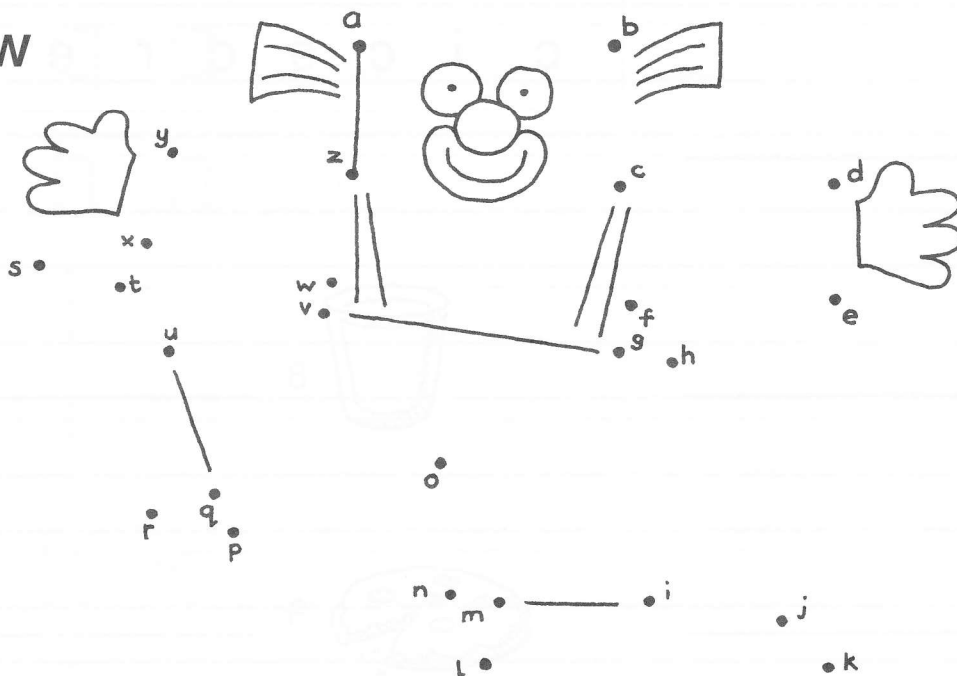

● Odd one out

Helen Tabby Goodbye Bix \_\_\_\_\_

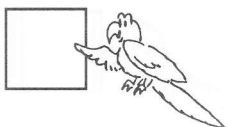

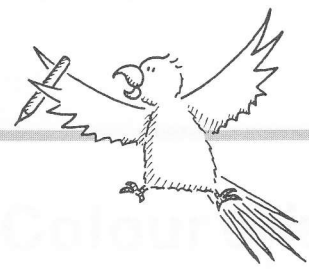

● Write



1 lemonade

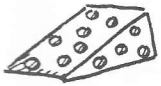

2 \_\_\_\_\_



3 \_\_\_\_\_



4 \_\_\_\_\_



5 \_\_\_\_\_

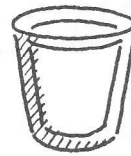

8 \_\_\_\_\_

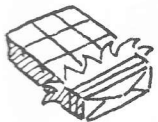

6 \_\_\_\_\_



9 \_\_\_\_\_



7 \_\_\_\_\_



10 \_\_\_\_\_

q	l	e	m	o	n	a	d	e
b	r	c	h	e	e	s	e	f
o	r	a	s	a	p	p	l	e
z	s	a	n	d	w	i	c	h
n	a	b	a	n	a	n	a	b
c	h	o	c	o	l	a	t	e
c	a	k	e	r	m	i	l	k
z	x	q	p	i	z	z	a	o
c	i	c	e	c	r	e	a	m



a a a a

b b b b

c c c c

d d d d

e e e e

f f f f

g g g g

h h h h

i i i i

j j j j

k k k k

l l l l

m m m m

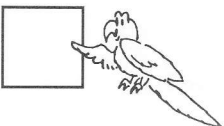



n n n n

o o o o

p p p p

q q q q

r r r r

s s s s

t t t t

u u u u

v v v v

w w w w

x x x x

y y y y

z z z z



A A A A

B B B B

C C C C

D D D D

E E E E

F F F F

G G G G

H H H H

I I I I

J J J J

K K K K

L L L L

M M M M

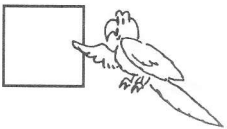

N N N N

O O O O

P P P P

Q Q Q Q

R R R R

S S S S

T T T T

U U U U

V V V V

W W W W

X X X X

Y Y Y Y

Z Z Z Z



Handwriting practice lines with faint background letters: A, B, C, D, E, F, G, H, I, J, K, L, M, N, O, P, Q, R, S, T, U, V, W, X, Y, Z.

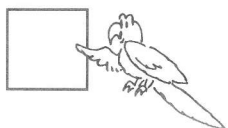

A A a a

H H h h

T T t t

A H H A H A A A H H

G G g g

P P p p

p g p g g p g p p g g p

N N n n

R R r r

n n r r n n r r n r n

W W w w

M M m m

w m m w m m m w w m



**B** B b b

**D** D d d

b d b d d b b b d d d b d

**L** L l l

l l l l l l l l l l l l

**I** I i i

l l i i i i i i i i i i i i

**F** F f f

**E** E e e

F F E E F F F E E F

**K** K k k

**X** X x x

k x k k x x k k k x x k

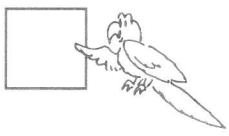



S S

s s

Z Z

z z

S Z S Z S S Z Z S Z S Z

O O

o o

C C

c c

O C C O O O C C O C O C

Y Y

y y

U U

u u

V V

v v

U U V U V V U U V V U V

J J

j j

Q Q

q q

J j J j Q q Q q U u Q q U u





**Get Set – Go!** is a lively language course for children learning English for the first time.

- **Get Set – Go!** has a carefully graded syllabus which provides steady progression in all four skills. The lower levels emphasize speaking and listening but also lay a foundation for the more demanding comprehension and story-writing skills in later levels.
- **Get Set – Go!** is based around a variety of texts and activities, including entertaining stories, songs and games, which are all carefully matched to the interests of children.
- **Get Set – Go!** Workbooks reinforce the language learnt in the Pupil's Books and include special revision sections.
- **Get Set – Go!** Teacher's Books provide teachers with clear guidance and lots of extra ideas. They also include tests which record children's progress.
- **Get Set – Go!** is easy to use and fun to use!

Each level consists of: Pupil's Book  
Workbook  
Teacher's Book  
Cassette

There are also flashcards at the first level.

**OXFORD UNIVERSITY PRESS**



[www.oup.com/elt](http://www.oup.com/elt)